



Accurate Sensing Technologies

We measure accurate temperature in extreme conditions

AST A250 EM /A450 EM PL/TL

Non-contact Infrared Pyrometers

USER MANUAL



AST - Accurate Sensing Technologies

188A, B-169 (Part), B-188 (A),
Road No. - 5, Mewar Industrial Area, Udaipur (Rajasthan) - 313003

Phone : +91-9352506032

Email : sales@astinfrared.com

Index

| | |
|---|-----------|
| 1. Chapter - 1 | 1 |
| General information | |
| 2. Chapter - 2 | 2 |
| Introduction | |
| 2.1 Product Key Features, Application and Range | |
| 2.2 Technical specification | |
| 2.3 Optics | |
| 3. Chapter - 3 | 5 |
| Basics & Installation of Pyrometer | |
| 3.1 Basics of Infrared temperature measurement of an object | |
| 3.2 Installation | |
| 3.3 Location Selection | |
| 3.4 Mechanical Accessories | |
| 3.5 Electrical Installation | |
| 4. Chapter - 4 | 13 |
| Software installation | |
| 4.1 Installation | |
| 4.2 Parameters in main screen | |
| 5. Chapter - 5 | 20 |
| Android Application Software | |
| 5.1 Installation Process | |
| 5.2 Communication | |
| 5.3 Operation | |
| 5.4 Datalogging & Online graph | |
| 6. Chapter - 6 | 24 |
| Calculate Spot size | |
| 7. Chapter - 7 | 25 |
| Maintenance | |
| 8. Chapter - 8 | 26 |
| Serial communication protocol | |
| 9. Appendix B | 31 |
| 10. Appendix C | 32 |

Chapter - 1

General Information

Congratulations on choosing this high quality and highly efficient AST pyrometer for non contact temperature measurement.

Please read this user manual carefully, step by step, including all notes of security, operation and maintenance before installing the pyrometer. This manual contains all the necessary instructions for set up and operation of the pyrometer. This section provides an overview about important safety regulations.

Some Important Safety Regulations Given Below

1. Safety Precaution

Each person working with pyrometer must read the user manual before operation. The pyrometer has only to be used for the purpose described in manual. The pyrometer works only with a potential free low voltage of range 24VDC. This voltage is not harmful for user. The pyrometer may contain harmful material and hence it should not be disposed of with normal waste.

2. Packaging and Storage

Always use a shock proof package for shipment of pyrometer. It should be sealed to protect it against humidity. Also protect the lens of pyrometer with cover. They should be stored at the temperature range from -20°C to 70°C.

3. Limit of Liability and Warranty

All general information and notes for handling, maintenance and cleaning of this instrument are offered according to the best of our knowledge and experience.

AST reserves the right to revise this document and to make change from time to time in the content hereof without obligation to notify any person or persons of such revisions or changes

AST instruments have a warranty of two year from the invoice date. This warranty covers manufacturing defects and faults which arise during operation only if they are the results of defects caused by AST.

AST does not accept liability for any damages or losses which might occur, including consequential damages and financial losses, as a result of use of the instrument.

4. Copyright

All rights reserved . this document may contain proprietary information and shall be respected as a proprietary document to AST with permission for review and usage given only to the rightful owner of the instrument with which this document is associated.

Chapter - 2

Introduction

AST A250 EM /A450 EM PL/TL are specially designed highly accurate digital pyrometers to provide high performance and low maintenance of non contact temperature measurement in demanding industrial environment.

2.1 Product Key Features, Application and Range

The AST A250 EM /A450 EM PL/TL pyrometers are especially designed for industrial purposes. They are suitable for high temperature measurement ranging from 210°C to 3000°C.

These pyrometers have solid body in stainless steel housing, which provides high operation safety even in rough industrial environment, and large variety of optics with fixed focus which can be easily used in all industrial areas.

AST A250 EM /A450 EM PL/TL both are having a fast response time of 2msec. The Pyrometer provided with bluetooth V2.0 for communication between pyrometer & Android mobile, RS-232 & 485(User Selectable) for communication between pyrometer & PC software Infracore. Response time, emissivity, sub-range and peak picker selection can be preset ex-works or adjusted through available software.

The pyrometer temperature measurement method utilizes the fact that objects emit thermal radiation in an amount that directly corresponds to their own temperature and surface emissivity.

The pyrometer sensor detects the amount of infrared radiation emitted by the measured object (target). The infrared signal is analyzed and the temperature it represents is analyzed by built-in microprocessor. AST A250 EM /A450 EM PL/TL work in 4-wire technology.

The applications in which AST pyrometers can be used are

- ✓ Induction heating
- ✓ Casting
- ✓ Annealing
- ✓ Welding
- ✓ Forging
- ✓ Sintering
- ✓ Melting
- ✓ Rolling
- ✓ Hardening etc.

Standard Item supplied with AST A250 EM /A450 EM PL/TL

- ✓ AST pyrometer
- ✓ Connection cable 12-core (length - 5 m)
- ✓ Digital cable 3-core (length - 1.5 m)
- ✓ AST software CD
- ✓ Manual
- ✓ Certificate of calibration

2.2 Technical Specifications

| Model | A250 EM PL/TL | A450 EM PL/TL |
|--|--|-------------------------|
| Temperature Range (Analog sub-range adjustable) | 210°C....1350°C 250°C....1800°C 300°C....2500°C 350°C....3000°C | 600°C....2500°C |
| Spectral Range | 1.6 μm | 1.0 μm |
| Photodetector Type | InGaAs | Si |
| Distance to Spot Size Ratio | 50:1 (210°C....1350°C) 100:1 (250°C....1800°C) 200:1 (300°C....2500°C) 200:1 (350°C....3000°C) | 200:1 (600°C....2500°C) |
| Emissivity (ε) | 0.1....1.0 adjustable (Through Software or External 4 - 20 mA Input) | |
| Response Time | 2 msec adjustable upto 10 sec | |
| Accuracy | ± 0.3% of the measured value + 1°C | |
| Repeatability | 0.1% of reading in °C + 1°C | |
| Sighting Options | Laser Pilot Light (PL) / Through The Lens (TL) | |
| Analog Output | 0-20mA, 4-20mA, 0-10V (User selectable) | |
| Digital Output | Bluetooth V2.0 RS-232/RS-485 (User selectable) *At a time only one digital output possible | |
| Operating Temp. Range | 0°C.....70°C 0°C.....200°C (With water cooling jacket) | |
| Storage Temp. Range | -20°C...70°C | |
| Adjustable Parameters and Features via Software | Emissivity, Response Time, Clear Time(Peak Picker), Analog Output, Analog Scale (Sub Range), Unit Of Temperature(°C/°F), Communication mode (Comm. mode), Record feature etc | |
| Power Supply | 12V to 28V DC with reverse voltage protection | |
| Power Consumption | Max 2.5 watt | |
| Laser Power | <1 m watt | |
| Protection Class | IP65 | |
| Housing | Stainless Steel | |
| Isolation | Power supply, Digital output and Analog output are galvanically isolated against each other | |
| Operating Humidity | 10-95%, Non-Condensing Conditions | |
| Weight & Dimensions | 600g Dia= Ø 49.5 mm; Length=118mm | |

Dimensions

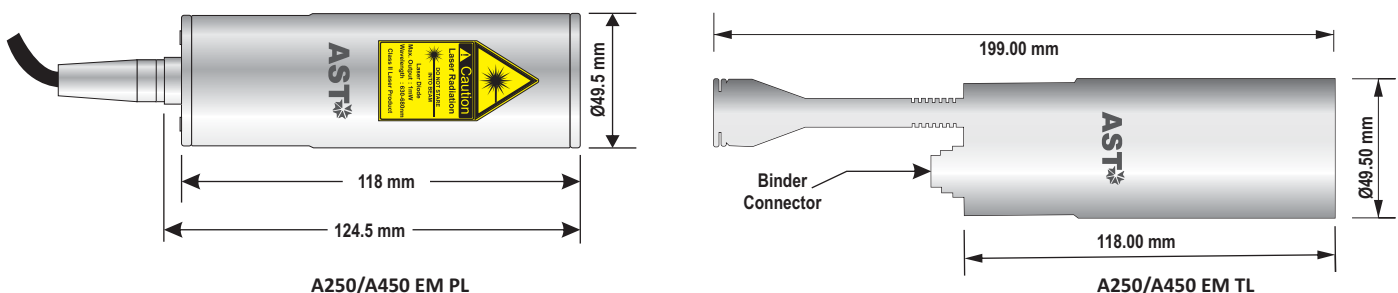

Fig. 1 Dimensions of Pyrometers

2.3 Optics

The pyrometer measure temperature by receiving heat radiation from the object whose temperature has to be measured. This heat radiation is passed through the lens sensor and then converted to an electrical signal. The farther the measured object is from the pyrometer, the larger the area that will be measured by the pyrometer. Depending on customer need, the pyrometer is designed with fixed optics.

Table 1 :Some fixed optics focus is as below

| Manufactured working distances WD (mm) | Spot Sizes(mm) | | | |
|--|-------------------------------------|--------------------------------------|--|--------------------------------------|
| | A250 EM 210°C - 1350°C (50:1) | A250 EM 250°C - 1800°C (100:1) | A250 EM 300°C - 2500°C 350°C - 3000°C (200:1) | A450 EM 600°C - 2500°C (200:1) |
| 350 | 7 | 3.5 | 1.75 | 1.75 |
| 500 | 10 | 5 | 2.5 | 2.5 |
| 700 | 14 | 7 | 3.5 | 3.5 |
| 800 | 16 | 8 | 4 | 4 |
| 1000 | 20 | 10 | 5 | 5 |
| 1500 | 30 | 15 | 7.5 | 7.5 |
| 2000 | 40 | 20 | 10 | 10 |
| 2500 | 50 | 25 | 12.5 | 12.5 |
| 3000 | 60 | 30 | 15 | 15 |
| 5000 | 100 | 50 | 25 | 25 |
| Aperture(A) | 11 | 11 | 11 (300 - 2500°C) 4 (350 - 3000°C) | 12(600 - 2500°C) |

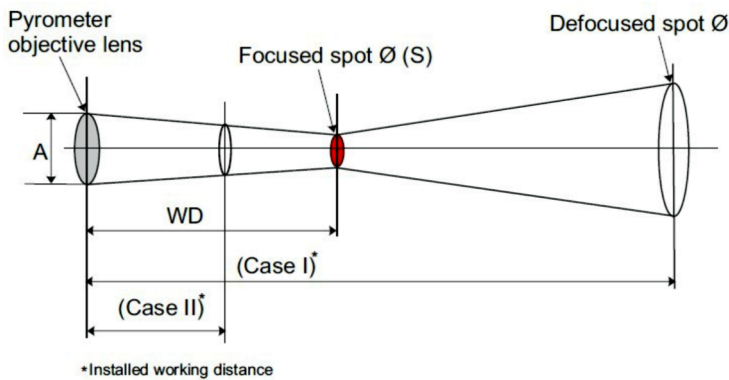

Fig. 2 Spot Size

* Manufactured working distance (WD) mentioned on the pyrometer.

If the pyrometer is not installed at manufactured working distance (WD) then spot size at actual installed distance should be calculated. For example, if factory made working distance is 500 mm & pyrometer is AST A250 EM(250 - 1800°C) then spot size is 5mm (as given in table). If user installed this pyrometer at 1000mm then spot size is not 10mm (as given in table), user should have to calculate as given below method.

Case-I: If installed working distance is greater than manufactured working distance

$$\text{Installed Spot size} = \frac{\text{Installed working distance (Case I)}}{\text{WD}} \times (S + A) - A$$

Case-II: If installed working distance is smaller than manufactured working distance

$$\text{Installed Spot size} = \frac{\text{Installed working distance (Case II)}}{\text{WD}} \times (S - A) + A$$

Where : S= manufactured spot size of pyrometer(mm), A = It shows the value of lens opening (aperture in mm)

Chapter - 3

Basics & Installation of the Pyrometer

3.1 Basics of Infrared temperature measurement of an object

Each and every object emit definite amount of infrared radiation and its intensity varies according to the temperature of object. Wavelength of infrared radiation lies approximately between 0.7 to 1000 μm depending on the material and properties of object. Infrared radiations are sometimes also referred to as “heat radiations” depends mostly on the material. This material dependent constant value is known as “emissivity”, have a look at appendix B for emissivity values.

3.1.1 Emissivity (ϵ)

Emissivity is the ratio of energy radiated from an object to the exterior and energy radiated from blackbody. The emissivity varies with the surface condition of the object and also with temperature variation and wavelength. If this value is not accurate, then the true temperature cannot be measured. In other words a variation or change in emissivity will cause a change in the measurement.

If the value of emissivity low, your measured results may contain some errors due to interfering infrared radiations from objects which are behind the target object like heating systems, fireclay brick etc. Usually such type of problems occurs while measuring very thin materials like glass, plastic etc or some reflecting surface. This error can be reduced if the sensor is shielded from reflecting radiation sources and also by properly, carefully installing the device.

By the application of Kirchhoff's law of thermal radiation “at thermal equilibrium, the emissivity of the body is equal to its absorptivity (α)”. So for perfect black body, ϵ is 1 while any real object would have ϵ less than 1. Also the transmissivity (τ) and reflectivity (ρ) is zero. The sum of absorptivity, reflectivity and transmissivity is always 1.

$$\alpha + \rho + \tau = 1$$

By emissivity factor materials can be categorized as

- ✓ Metals
- ✓ Non metals
- ✓ Transparent materials

3.1.2 Calculation of emissivity of target object

There are various methods to do so but one of most prominently used is Calculate the actual temperature of target object using a RTD, Thermocouple etc. Measure the object's temperature; and adjust emissivity settings unless correct temperature value is reached. Hence correct emissivity is measured of the target object.

3.2 Installation

3.2.1 Mechanical installation of pyrometer

After all preparations are completed you can install pyrometer. Installation of pyrometer depends on the type of bracket you are using and the type of surface.

3.2.2 Distance of pyrometer from object

The desired spot size on the target will determine the maximum measurement distance and the focal length of the optical module. To avoid wrong readings the spot size of target must contain entire field view of the pyrometer. The pyrometer must be mounted so the entire field of view is the same or smaller than the desired target size. This is indicated in the below diagram.

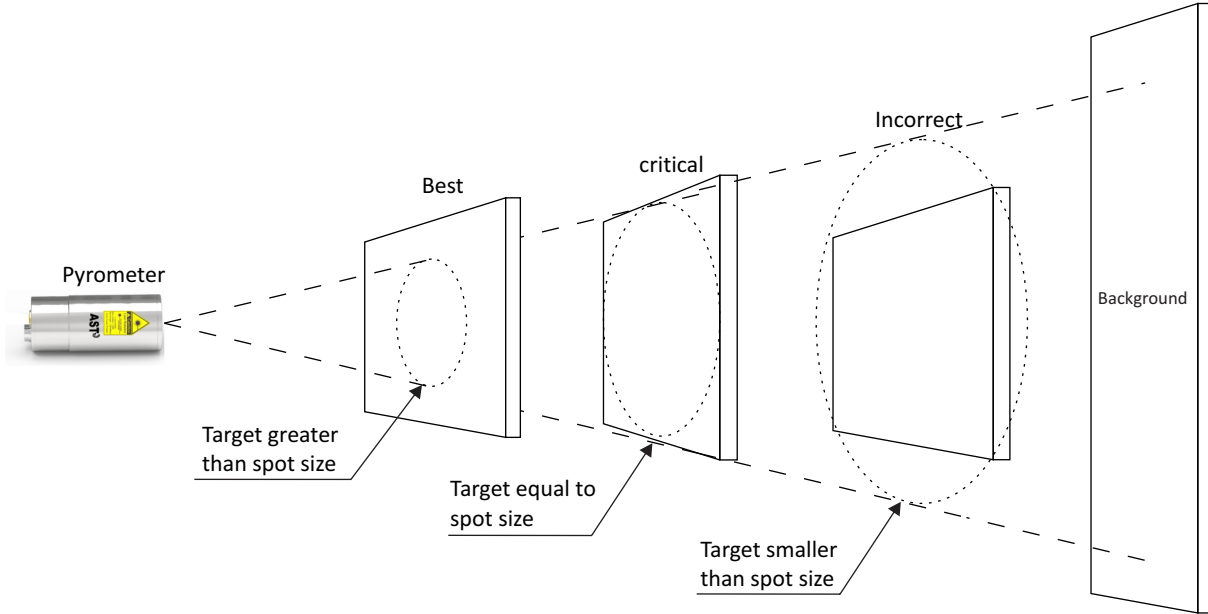

Fig.3 Proper mounting of pyrometer

3.2.3 Viewing Angles

The pyrometer can be placed at any angle from the target object up to 30°.indicated in the below diagram.

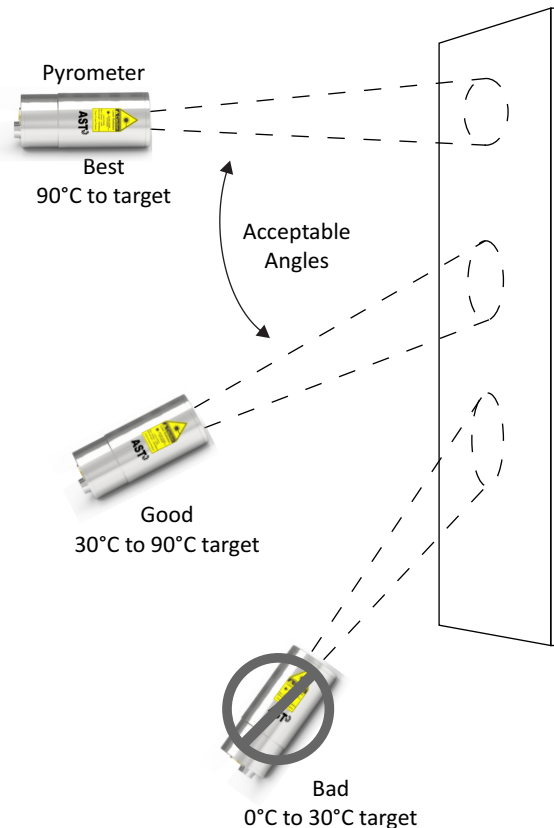

Fig. 4 Pyrometer Acceptable Viewing angles

3.3 Location selection

Qualified operating personnel should do the installation. Location should be good enough so that pyrometer should get continuous infrared radiation.

Pyrometer distance from object is according to below points:-

1. Pyrometer spot size should be small than object size.(read 3.2.2 & 3.2.3)
2. Know your pyrometer spot size according to point 2.3.
3. Pyrometer ambient temperature should be within 0° to 70°C (read 3.3.3).

3.3.1 Correct Positioning of the pyrometer

With pilot light (PL)

A laser targeting light will help to correct the position of the pyrometer. It is recommended that laser should be switched off while measurement. It will increase the life of laser. To avoid measuring errors caused by a too big spot size the pyrometer must be fixed in the correct measuring distance, so that the object under measurement fills the spot size.

With through the lens sighting (TL)

In case of through the lens sighting a reticule circle marks the position of the measuring spot. This circle is true-sided and parallax-free.

Note: *The laser spot (PL) / reticule circle (TL) is only for indication of measuring spot, not exactly shows the measuring area.*

3.3.2 Mounting of pyrometer

To install the pyrometer at the place of measurement a mounting support is supplied as an accessory, after losing the clamp screws, it can be fastened correctly.

3.3.3 Ambient temperature

The allowed operation temperature for the pyrometer is 0°C to 70°C. Therefore if pyrometer is to be used above 70°C upto 200°C water cooling jacket with built in air purge unit is used otherwise it may damage the pyrometer. The ambient temperature is dependent on the temperature and flow rate of cooling water. Details of water cooling jacket& air purge are given in point 3.4.1.

3.3.4 Atmospheric conditions

The pyrometer cannot receive the full infrared energy for the measurement if atmospheric conditions like smoke, dust or steam are present and hence it result in measuring error. An air purge unit can be helpful to avoid contamination such as dust and humidity on the lens. The air supplied should be at normal temperature with oil & moisture free. The air purge generates an air stream shaped like a cone and blows particles from the lens area.

3.4 Mechanical Accessories

3.4.1 Water Cooling Jacket

This accessory is very important in order to use pyrometer at higher temperature. A normal pyrometer can withstand a temperature of 0-70°C. For higher temperature applications the device must be used with water cooling jacket upto 200°C.(for mechanical drawing refer Appendix C.)

- Water pressure : < 10 bar
- Air pressure : < 0.5 bar
- Air consumption : 2...3 m³/h
- Ambient temperature : < 200°C
- Metal : Stainless steel
- Weight : 2.75 Kg



Fig. 5 Water Cooling Jacket (air purge, mounting clamp, water jacket combo)
(Reference no: 8000-02 (for PL)
8000-06 (for TL))

3.4.2 Air Purge

This accessory is used to keep dust, moisture, airborne particle and vapours away from the lens head so that correct sighting of target object can be done. (for mechanical drawing refer Appendix C.)

- Air pressure : < 0.5 bar
- Air consumption : 2...3 m³/h
- Metal : Aluminium
- Weight : 0.15 Kg
- Dry, clean air (Oil and dust free)



Fig. 6 Air Purge Unit
(Reference no: 8000-04)

3.4.3 Adjustable mounting stand

This adjustable mounting stand will provide appropriate movement to the pyrometer. (for mechanical drawing refer Appendix C.)

- Metal : Stainless Steel
- Weight : 0.9 Kg

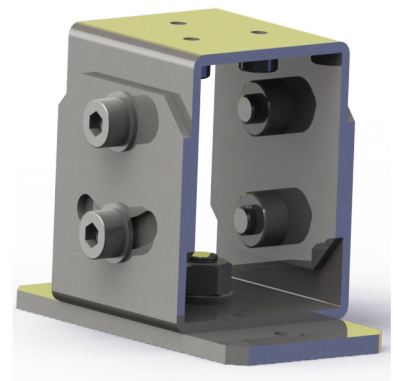

Fig. 7 Adjustable Mounting Stand
(Reference no: 8000-07)

3.4.4 Mounting Clamp

Mounting clamp can be used to hold the pyrometer.(for mechanical drawing refer Appendix C.) Fig. 8.

- Metal : Stainless Steel
- Weight : 0.45 Kg



Fig. 8 Mounting Clamp
(Reference no: 8000-05)

3.4.5 Combination of Accessories

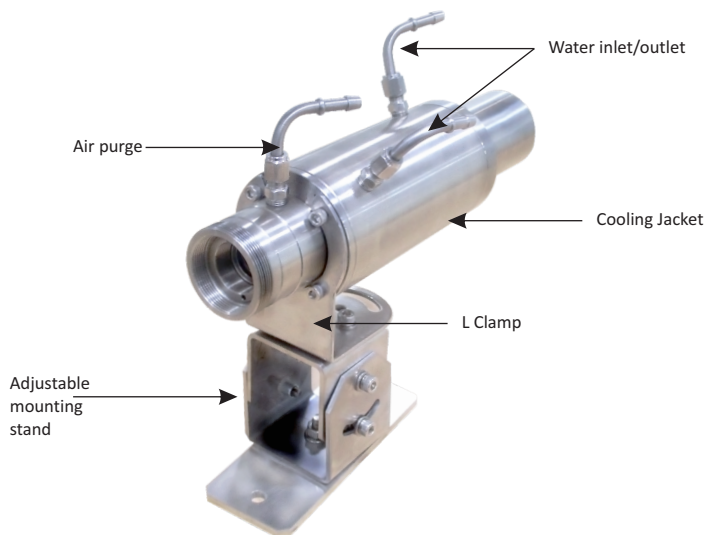

Fig. 9 Adjustable Mounting Stand + L Clamp
+ Water cooling jacket with air purge
(Reference no: 8000-02 or 8000-06 + 8000-07)

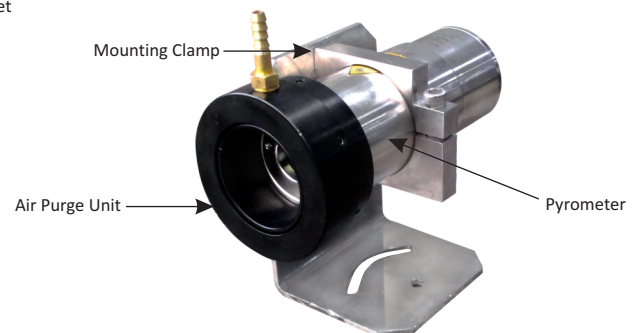

Fig. 10 Air purge unit + Mounting Clamp +
Pyrometer
(Reference no: 8000-04 + 8000-05)

3.5 Electrical Installation

3.5.1 Power Supply

24V DC (well stabilized ripple max 50mV).The input power supply is 110/230v AC check the polarity before connecting the device.

Device has following specifications

- Power supply I/P : 100 - 240VAC, 0.35A
50/60 Hz
Power supply O/P : +24V DC, 0.625A



Fig. 11 12-Core Cable
(Reference no: 7002-02)



Fig. 12 Power Supply Unit
(Reference no: 9000-02)

3.5.2 Connector pin assignment on the back of the pyrometer

For connecting pyrometer with computer via connector pin (on the back of pyrometer) connection diagram is shown as under. Different colors and their indication is also shown in the table 2. So connections need to be done according to color, indication, used for particular purpose as in the table 2.

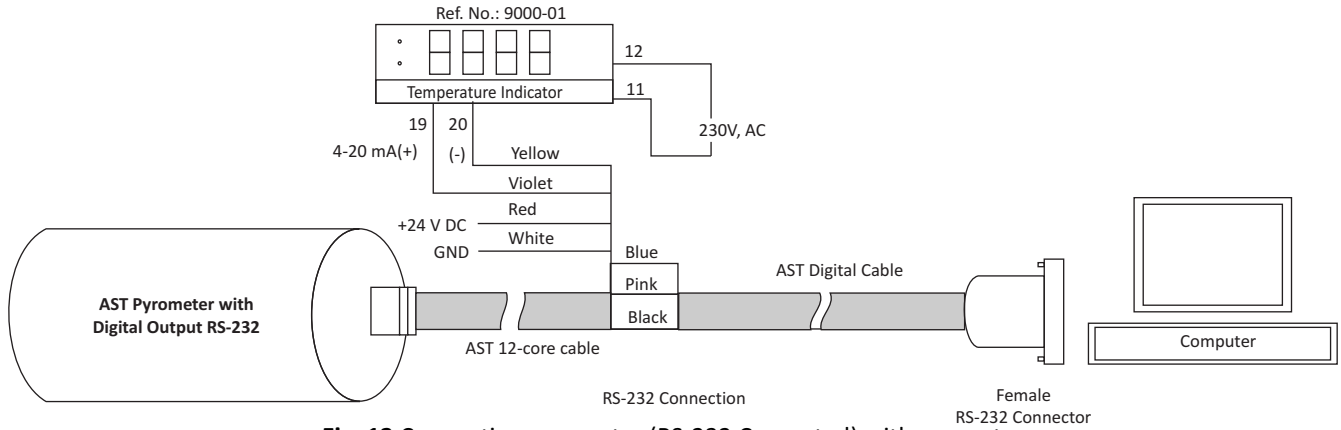

Fig. 13 Connecting pyrometer (RS-232 Converted) with computer

Table 2 : Color code & Pin specification for pyrometer connections

| Pin | Colour | Indication | Used for |
|-----|-------------|--|---------------------------------|
| A | Red | + 24 V DC In | Power supply |
| G | White | Ground | |
| C | Blue | TxD (RS-232) / D- (RS-485) | RS-232/ RS-485 communication |
| D | Pink | RxD (RS-232) / D+ (RS-485) | |
| F | Black | RS-232 communication | |
| H | Yellow | (-) 4-20mA / 0-20mA | Analog current output |
| M | Violet | (+) 4-20mA / 0-20mA | |
| J | Brown | Short / Open both wires for laser ON/OFF | Laser ON/OFF |
| K | Green | | |
| H | Yellow | - (0-10V) | Analog voltage output |
| B | Grey | + (0-10V) | |
| E | Blue-Yellow | -mA | For external emissivity setting |
| L | Red-Grey | +mA | |

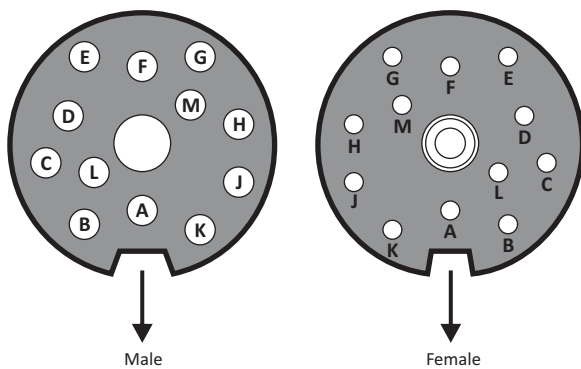

Fig. 14 12-pin Binder connector

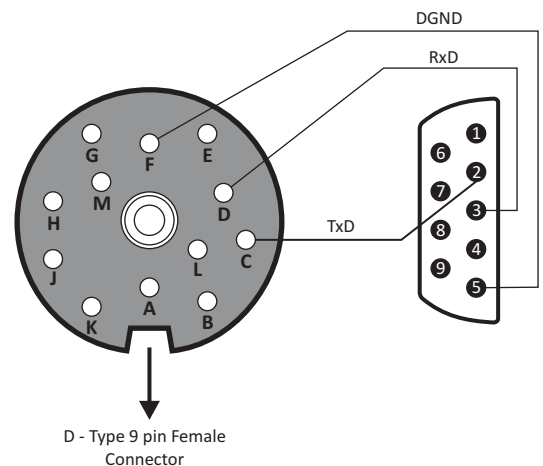

Fig. 15 RS-232 communication connection

3.5.3 Power ON Pyrometer

1. Connect the 12-core cable (Supplied with pyrometer) with pyrometer 12-pin binder connector given at the back side of pyrometer.
2. Connect the 12-core cable supply wire with +24V DC as given in table above.
3. Connect remaining wires as per your requirement (details given in table above).
4. Provide insulation for not used end points of 12-core cable.
5. Now, the pyrometer can be switch ON.

3.5.4 Converter RS-232 ↔ RS-485



The pyrometer can communicate with PC using RS-232 or RS-485. RS-232 is used only for short distances.

RS-485 is well suited for long distance transmission. Standard on PC is RS-232, so a converter is used which converts RS-485 to RS-232.

Fig. 16 Converter RS-232 ↔ RS-485
(Reference no: 9000-03)

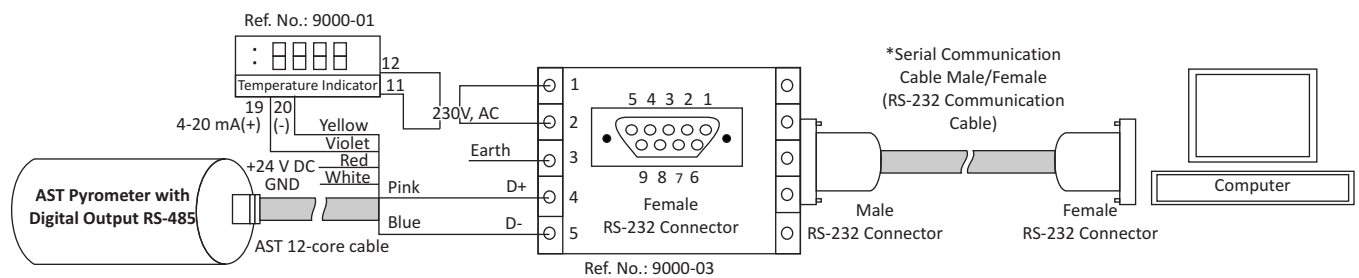

Fig. 17 RS-485 to RS-232 Connection

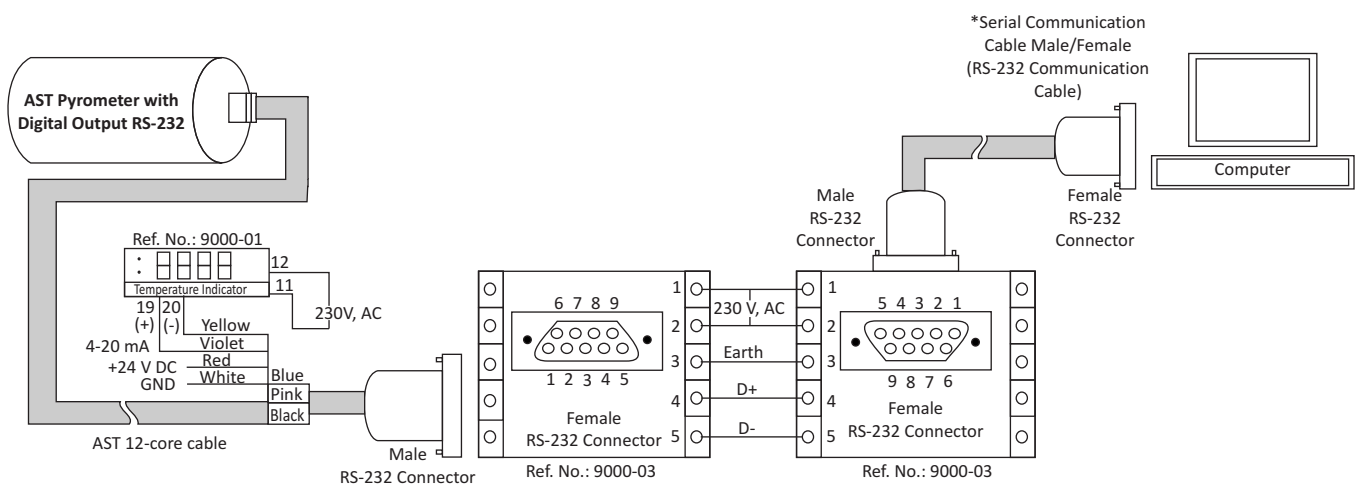

Fig. 18 RS-232 to RS-485 to RS-232 Connection

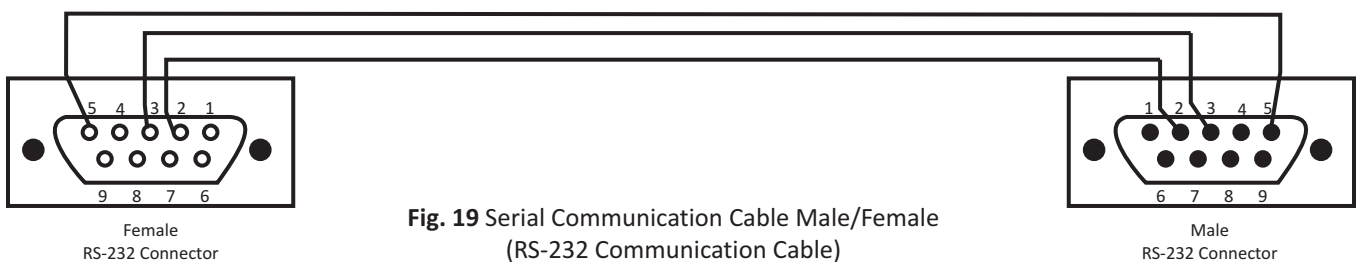

Fig. 19 Serial Communication Cable Male/Female
(RS-232 Communication Cable)

3.5.4 Connecting Multiple Pyrometers

In order to connect multiple pyrometers (Multiple pyrometer communication) to computer each pyrometer must have digital output RS-485 converted. Each pyrometer should be assigned a different address. For connection assessment have a look on the diagram below

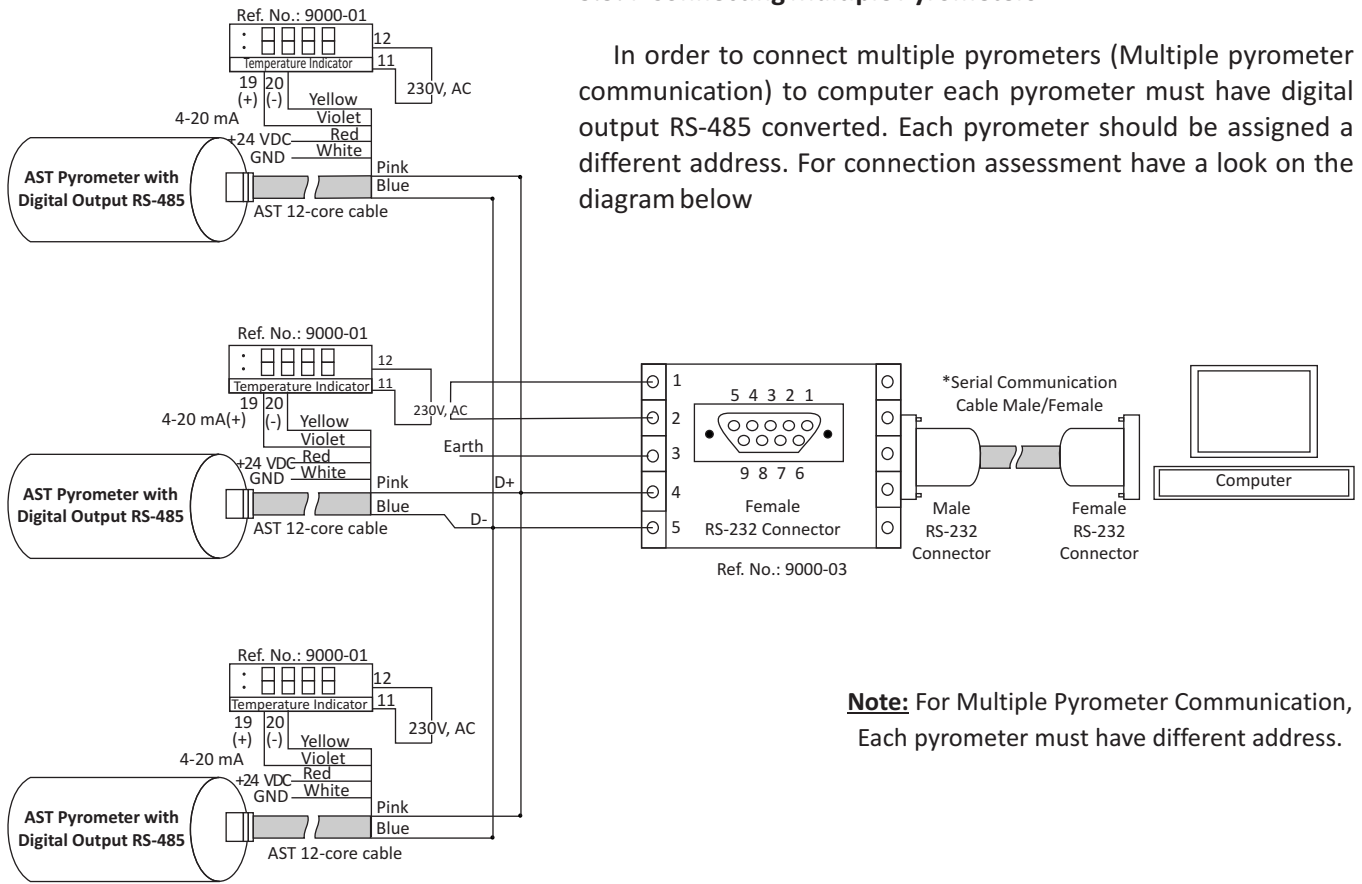

Fig. 20 Multi-Pyrometer Connection

Note: For Multiple Pyrometer Communication, Each pyrometer must have different address.

3.5.5 Display Instrument

To display the measured temperature 7 segment digital indicator is used. Device has following specifications:

| | | |
|------------------|---|---------------------|
| Power supply I/P | : | 100 to 240 V, AC/DC |
| Analog I/P | : | 4....20 mA |
| Retransmission | : | 4....20 mA |
| Power supply O/P | : | 24V, DC |
| Display | : | 4 Digits |
| Alarm | : | 2 |

3.5.6 Display & Parameterizer

AST P-120 is a high precision LED indicator for non contact temperature measurement. With indication of measured temperature user can easily parameterize a connected AST digital pyrometer without any PC.

Device has following specification:

| | | |
|-------------------|---|------------------------------|
| Power supply | : | 100 – 240V, AC or 24V, DC |
| DC analog O/P | : | 0-20 mA or 4-20 mA |
| Digital interface | : | RS-232 or RS-485 |
| Pilot light | : | Pilot light On/Off with keys |



Fig. 21 Temperature Indicator
(Reference no: 9000-01)



Fig. 22 Display & Parameterizer P-120
(Reference no: 9001-01)

Chapter - 4

Software Installation

The provided AST software “InfraSoft” offers digital PC interface RS-232 & RS-485. Using this software we can set all the parameters like response time, analog scale, emissivity, clear time, communication mode. This software provide all necessary information about pyrometer.

4.1 Installation

Install the pyrometer software using the installation guide file on CD ROM & restart your PC as per guidelines provided for installation. After installation of the software; Double click the application. It will open the screen of software.

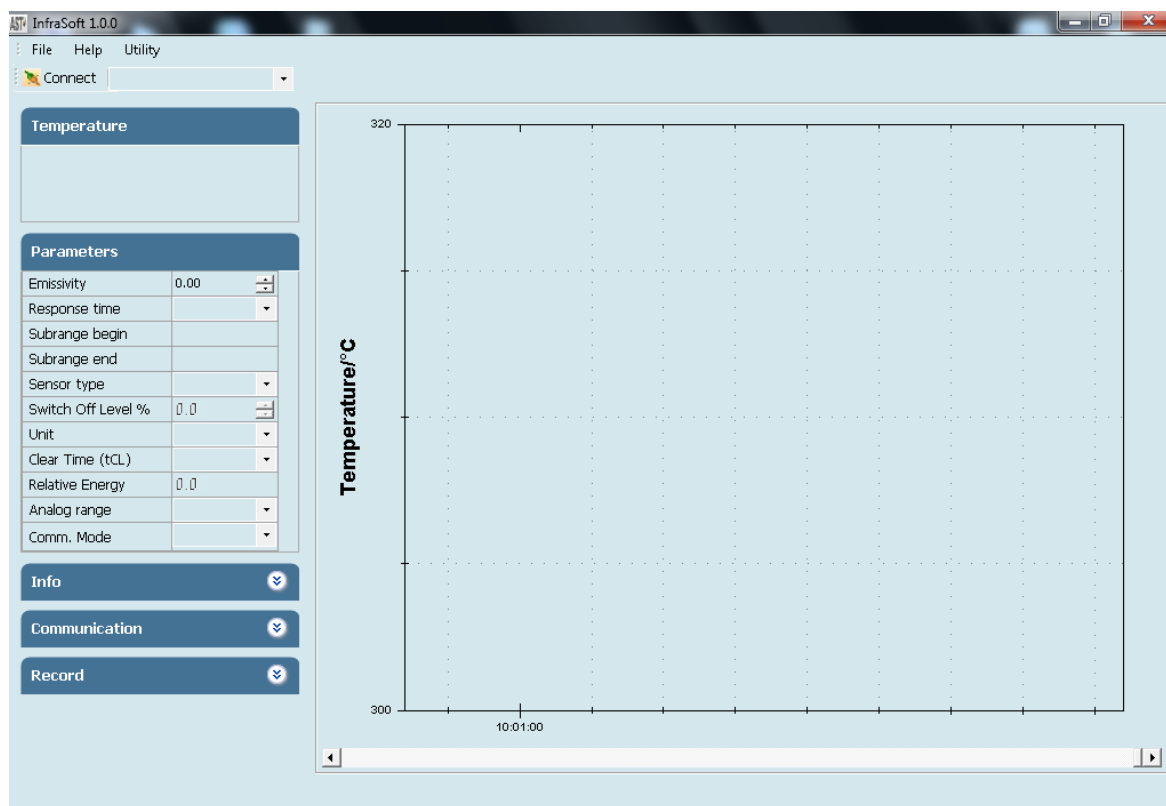

4.2 Parameters in main screen

4.2.1 Communication

Communication between the AST pyrometer and the software is implemented via a cable connected between the pyrometer and the PC serial port. This enables the acquisition and recording of data, as well as the transfer of commands from the software application to the AST pyrometer. Communication can be done by clicking on “Communication panel” and select correct COM Port address where pyrometer is connected. Also user has to select address of the pyrometer(Example: Default 01/ printed on the pyrometer sticker). Then click on CONNECT Button.

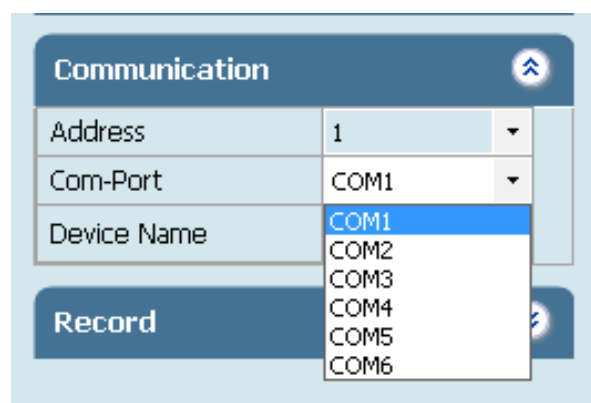

For communication of multiple pyrometers, select different com port and address.

4.2.2 Temperature

It shows the temperature measured by the pyrometer

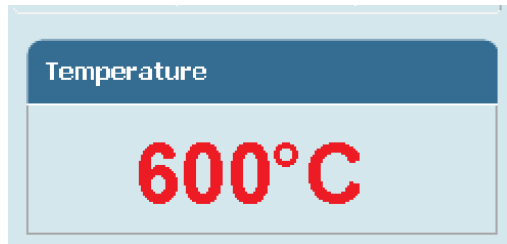

4.2.3 Parameter Setting

All user selectable device parameters can be set by using the software in the Panel "Parameter"

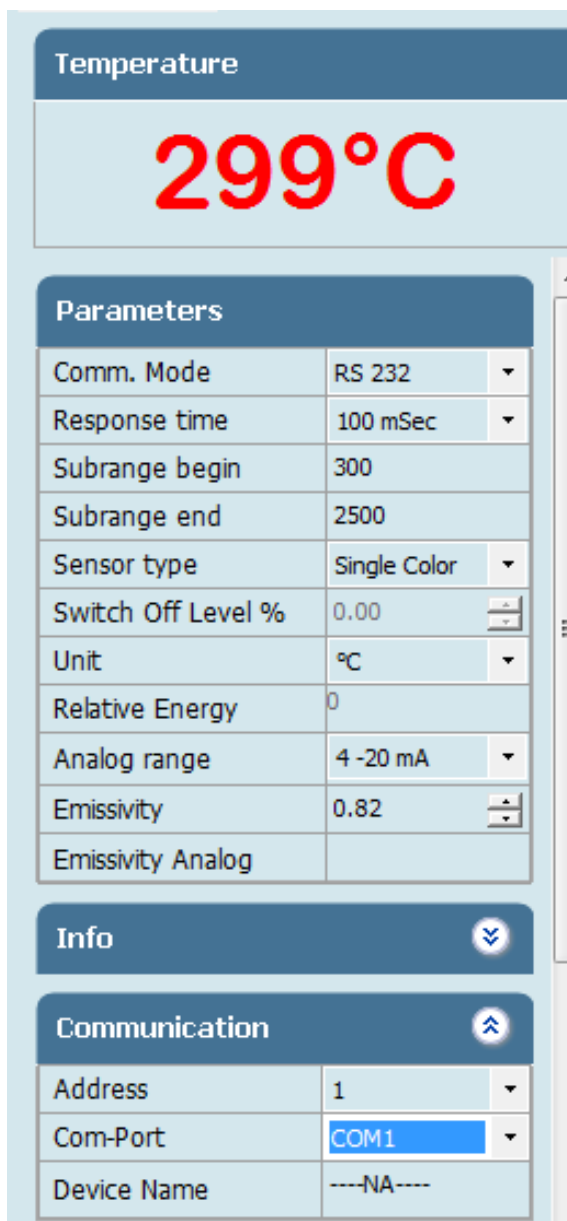

(A)Emissivity settings The emissivity can be set by clicking on "Parameters" If user select "Software" as emissivity mode then emissivity can be set by selecting or typing in desired emissivity directly in the description field. If user select "Analog" as emissivity mode then emissivity can be set by external 4 - 20mA Input.

(B)Response time The desired response time can be chosen in the panel Parameter by clicking the appropriate list box (as per the values available in the drop box of response time). This parameter is use to set the analog response time of pyrometer.

(C)Sub Range User can change the sub range of pyrometer in the panel Parameter. Sub range must be within the basic range of pyrometer, the minimum span between higher & lower range is 51. Analog output will be automatically set according to the sub-range by hitting "TAB" button.

(D)Sensor Type It shows pyrometer sensor type. User can change sensor type from two color to single color and vice versa (only applicable with two color pyrometer).

(E)Switch off level% (for two color pyrometer) The switch of level is the function that is used to avoid measurement errors caused by signals, which are too low. Although factory default is set to 15 %, the switch off limit can be adjusted between 2 and 50%.

(F)Unit User can change the measuring unit of temperature from "Centigrade" to "Fahrenheit" and vice versa.

(G) Peak Picker Setting Three Pickers are available in Pickers setting menu (Auto, tCL, Smart) & user can switch on any as per requirement, one at a time.

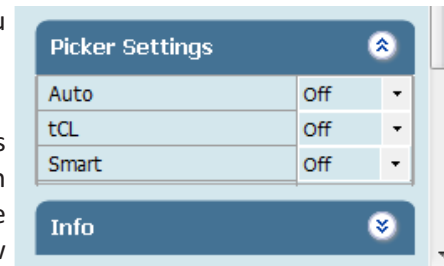

(G1) Auto “Auto” mode is used for discontinuous measuring task, such as object being transported on a conveyer belt in such a case the maximum value for each object has to be indicated. when the object passes the measuring beam of the pyrometer, the maximum value is stored until a new hot object appears in the measuring beam. The temperature which has to be recognized as “hot” is defined by the low limit of the adjusted sub range. The stored maximum value will be deleted when the temperature of the new hot object exceeds the low limit “from” of the sub range by at least 1°C. If a lower limit is not entered, the maximum value storage will be deleted whenever the low level of the full measuring has been exceeded.

(G2) Clear time (tCL) If the peak picker is switched on, the highest last temperature value will always be displayed and stored. As such, it may be beneficial to periodically clear and reset the stored values in order to obtain new temperature readings.

Example : If we set the tCL a s “6 sec” the highest last temperature value will be display for 6.0 sec to 12 sec then it capture next pick.

The following setting are possible :

OFF : At clear time “OFF” the maximum value storage is switched off and only momentary values are measured.

tCL (10msec...25sec) : Clear Time tCL can be set between 10msec and 25sec. When set, estimates the maximum values and holds it in two buffer memory. After the entered time, the storage will be deleted.

Clear Time feature is particularly useful when object temperature is not uniform across its dimension or the pyrometer is not constantly viewing an object to be measured. The peak picker works on two buffer memory to find maximum value over a defined interval. With the first memory, the highest measured value is held and is deleted alternately in the time interval set (clear time). The other memory retains the maximum value throughout the next time interval. The disadvantages of fluctuations in the display with the clock frequency are thereby eliminated.

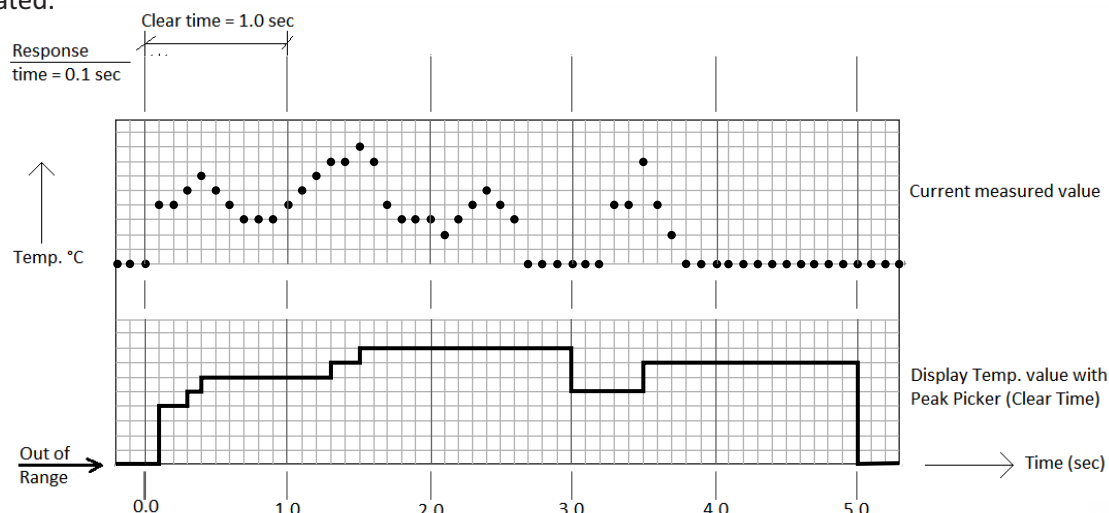

Note:

The maximum value storage coincides with adjustments made to response time. Therefore:

- (i) Clear time <= the adjusted response time is useless
- (ii) Clear times must be at least 5 times longer than the response time.
- (iii) Only maxima with full maximum value can be recorded, which appear at least 5 times longer than response time.

(G3) Smart If the smart picker is switched on, the highest last temperature value will always be displayed and stored. This feature is particularly useful when object temperature is not uniform across its dimension or the pyrometer is not constantly viewing an object to be measured.

Smart Picker Functions

Smart picker can be turn ON & OFF by using the software. When Peak picker is ON, the peak picker menu is enabled for setting of the parameters like decay rate function, reset below temperature and peak picker delay.

(I)Decay rate The Decay rate range is 0.00 to 166.66°C/sec. or 0.00 to 300°F/sec. depending upon °F/°C unit’s selection. The slowest Decay rate is 0 degrees per sec. This feature helps to eliminate erratic measurements and allows the peaked value to decay down to lower process temperature values as they occur. Decay rate is set to retain peak measured temperature value and ignore momentary decreases in measured temperature.

Temperature

199°C

| | |
|---------------------|--------------|
| Response time | 100 mSec |
| Subrange begin | 200 |
| Subrange end | 2000 |
| Sensor type | Single Color |
| Switch Off Level % | 0.00 |
| Unit | °C |
| Relative Energy | 0 |
| Analog range | 4 -20 mA |
| Emissivity | 1.00 |
| Emmissivity Analog | 1 |
| Set Emmisivity Mode | Software |
| Peak Picker Setting | |
| Software | |
| Analog | |

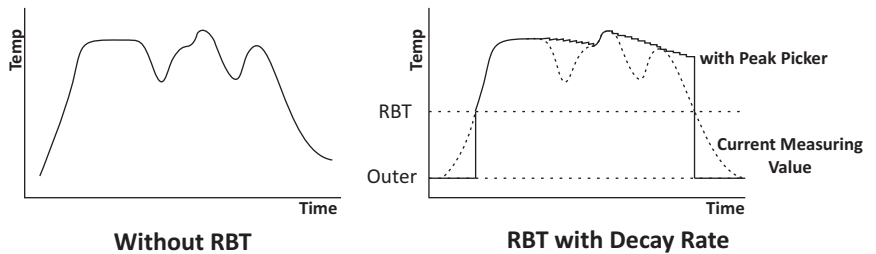

(II)Delay Time This function set the delay time in sec. before peak picker function starts. The delay time is selectable in the range 0.02 to 10.00 sec. Zero (0) turns delay time OFF. This function is used to delay the start of peaking action for upto 10 sec. following the detection of leading edge of a new target.

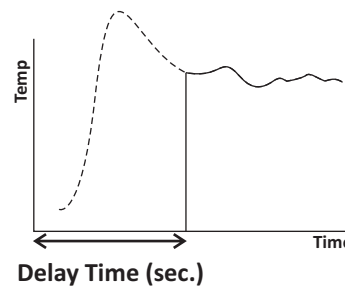

(III) Reset Below Temperature(RBT) The user can set RBT within the limit of pyrometer sub range. This function sets the temperature above which peak picker action starts. When the target temperature matches or is below the selected value, the sensor indicates temperature without picking action.

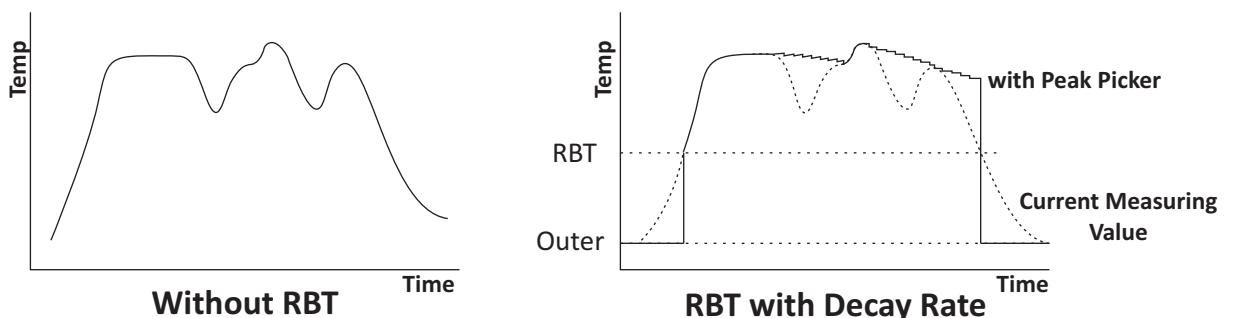

(H)Relative energy(for two color pyrometer) The relative energy shows a signal weakening which can be caused by contaminations of the optics or a viewing window or by dust in the field of view or a too small measuring object. Relative energy shows the measured intensity compared to the intensity, a black body radiation source would have at a determined ratio temperature of the pyrometer.

(I)Analog Range User can select the analog range from the option 4-20mA, 0-20 mA & 0-10V.

(J)Comm. Mode User can select the communication mode as per requirement [RS-232 / RS-485].

Note: For connection diagram from RS-232 to RS-485 & RS-485 to RS-232 Refer Page No:-9

To view parameters of multiple devices select the pyrometer name from the drop down list that appears at the top of the screen.

4.2.4 Device information

Pyrometer specific information will be displayed in the Info Panel

This screen shows the Model, basic range, serial number, version, Head temperature, internal temperature, working distance, spot size-aperture.

| Info | |
|----------------------|----------------|
| Model | AST A250 TL |
| Basic range | 300°C...1300°C |
| Serial number | 849 |
| FW Version | 11.25 |
| Head Temp. | 0°C |
| Internal temp. | 30°C |
| Working Dist..(mm) | 300 |
| Spot Size-Aprt. (mm) | 2-5 |

4.2.5 Record

Record is for continuous data logging. It records the measured temperature, emissivity with current date & time. To start data logging click on start button. If user wants to record emissivity, click on record emissivity button. After clicking Start button window appears where user can specify the file name & location. Record will be saved as **.txt** format and the name of file will be user define.

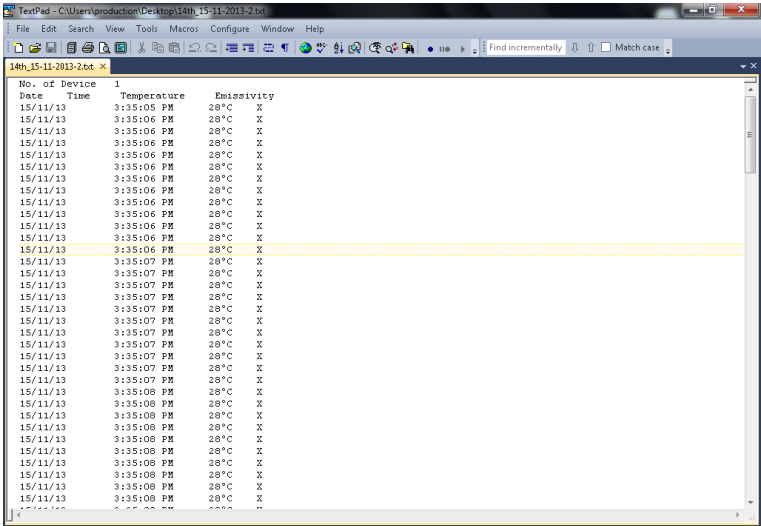

To record emissivity, click on **Record Emissivity** button.

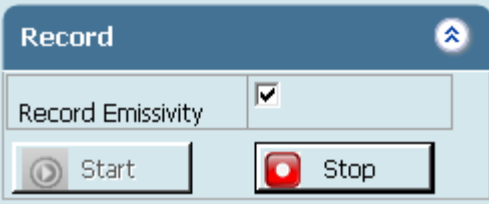

If user wants file in Spreadsheet format, user can export by choosing Excel Spreadsheet in file menu.

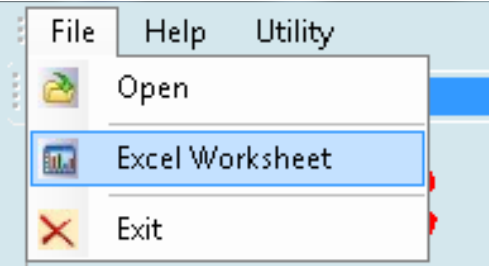

File will be stored in **.xls** format named as “export”. This “export.xls” file will be saved where the software is installed.

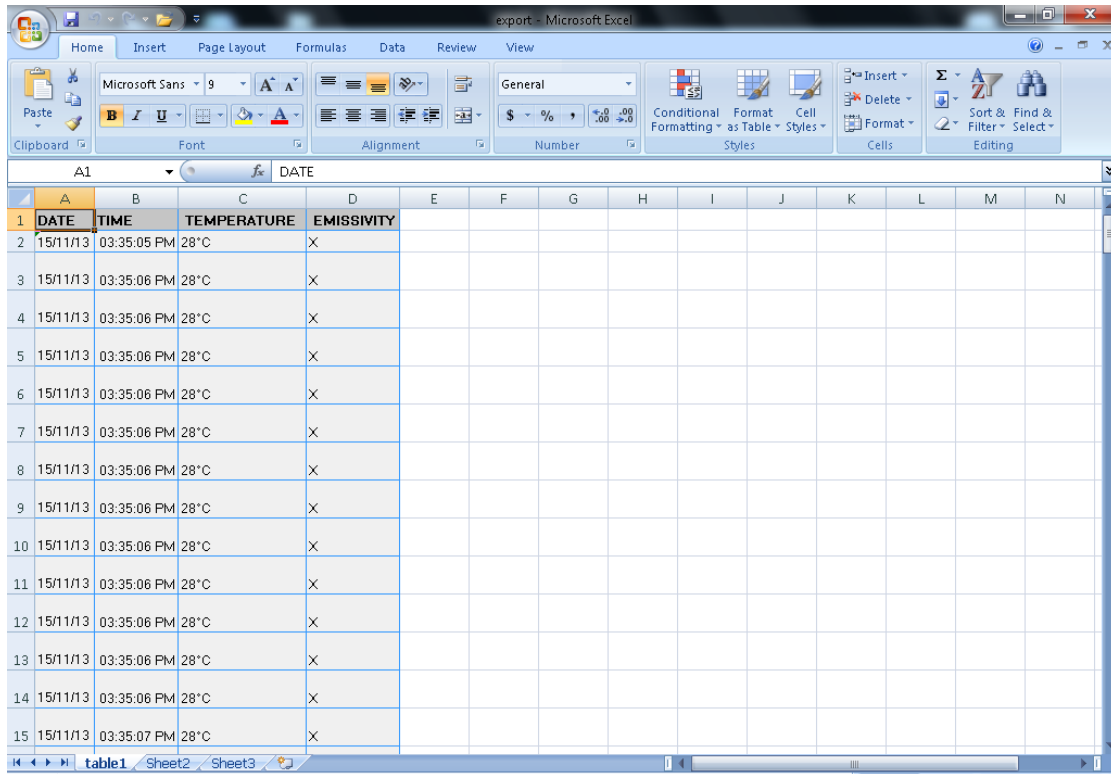

To see previous record open the file by clicking on menu **File** → **open**.
Screen containing historical trend & historical data will appear.

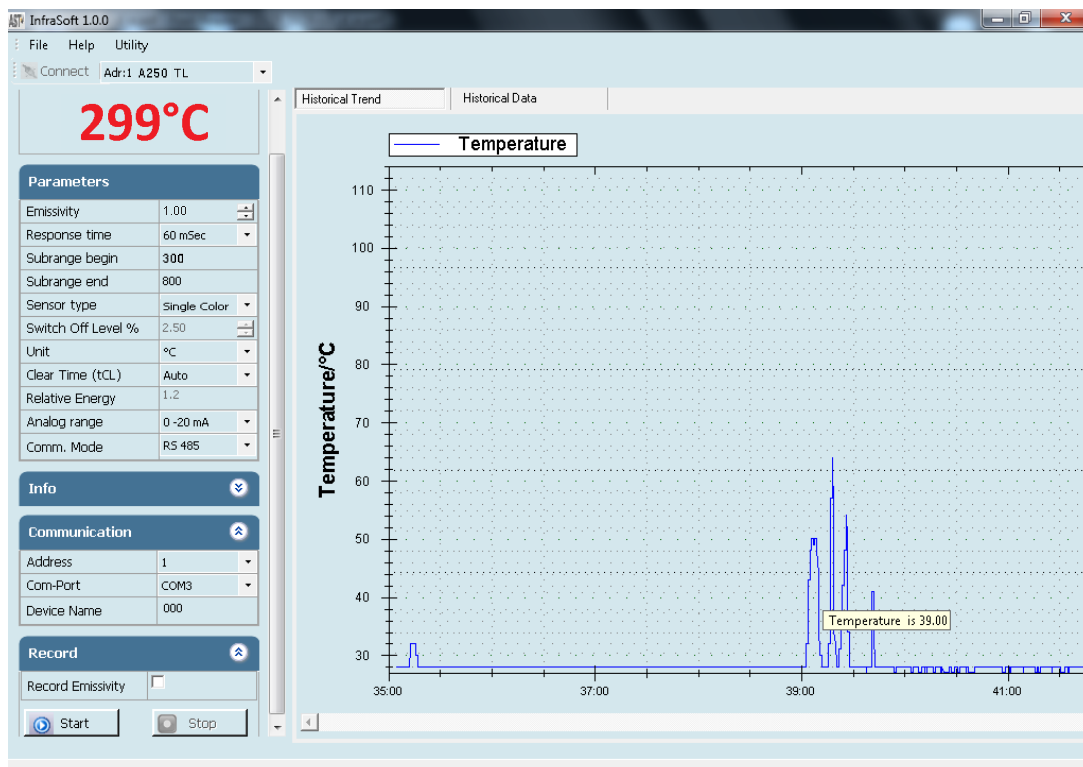

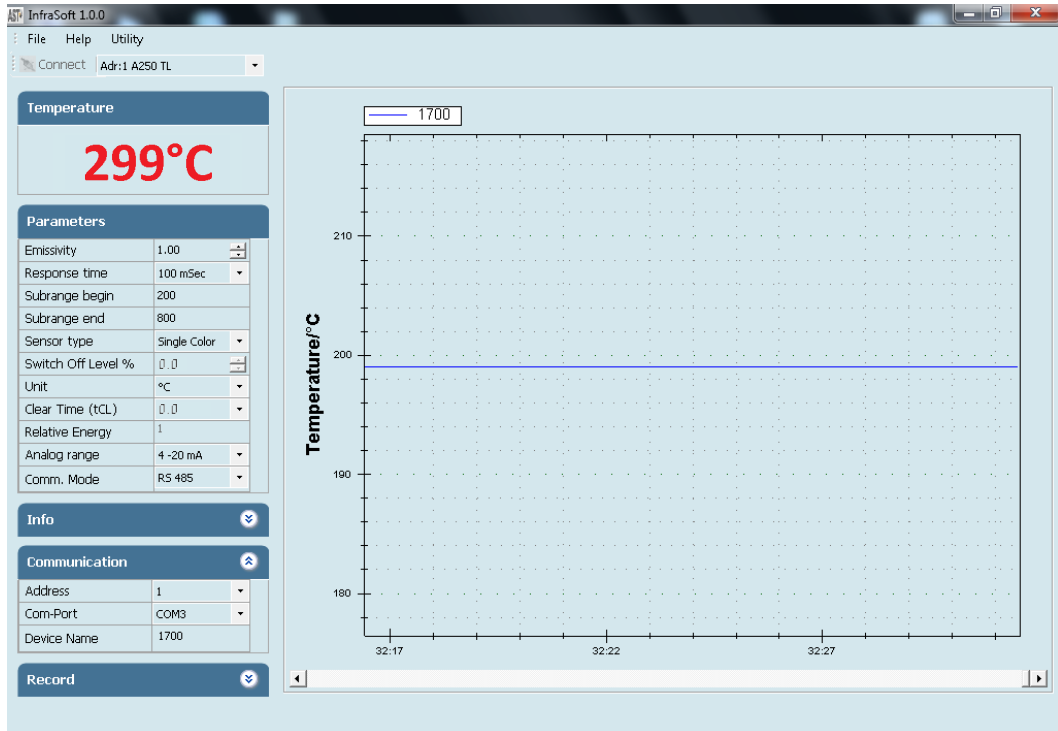

Temperature graph of connected pyrometer is displayed on right side of the screen. This shows the measured temperature corresponding to the time.

Note:

After connecting the pyrometer right click on the graph screen and choose "Set to default" option from pop-up menu.

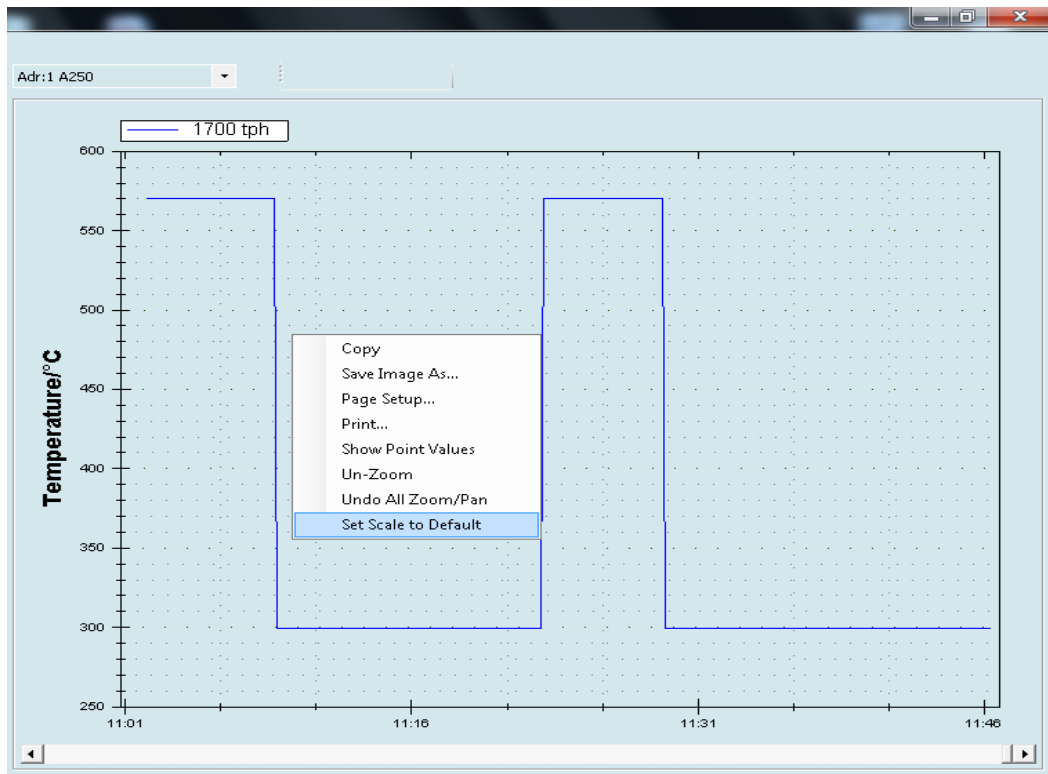

Chapter - 5

Android Application Software

5.1 Installation Process

AST provides “**infrasmart .apk**” for android phone. This apk is in software CD.

Special Note: - This apk is compatible with android version 4.0 and above

Following are the predefined steps to install apk in a mobile.

- (i) Copy apk file from CD in a mobile.
- (ii) Click on “**infrasmart .apk**” (Fig. 5.1)
- (iii) Next screen will be as shown below, click on settings (Fig. 5.2)

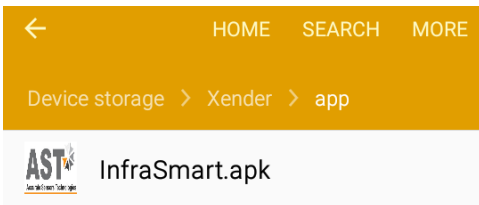

(Fig. 5.1)

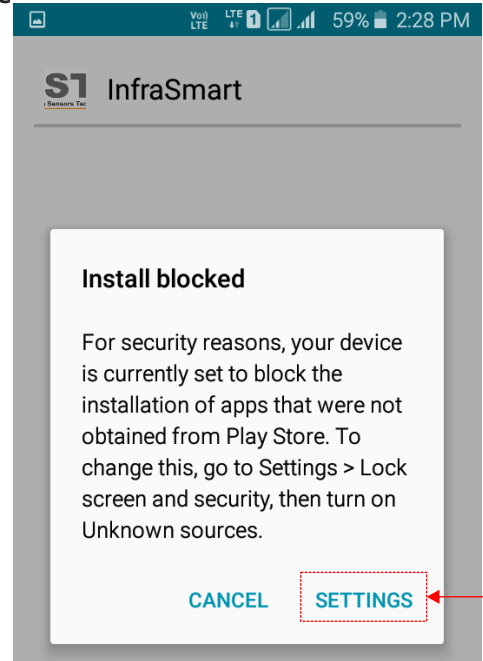

(Fig. 5.2)

(IV) “On” unknown sources, Pop up window will appear as below. (Fig. 5.3)

Tick mark on “Allow this installation only” check box (indicated by arrow in below screen) and then click “OK”. (Fig. 5.4)

(V) Next click on Install tab (Fig. 5.5)

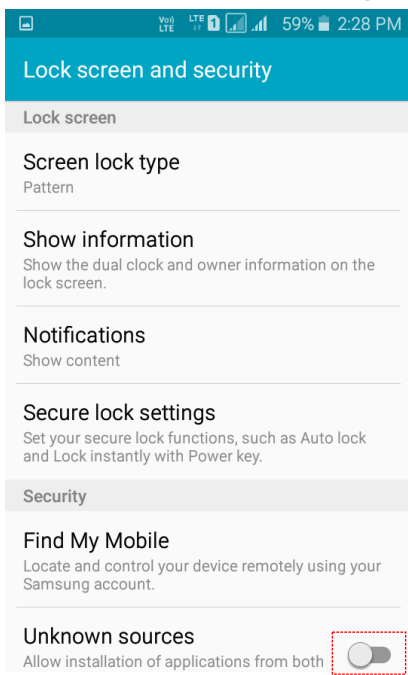

(Fig. 5.3)

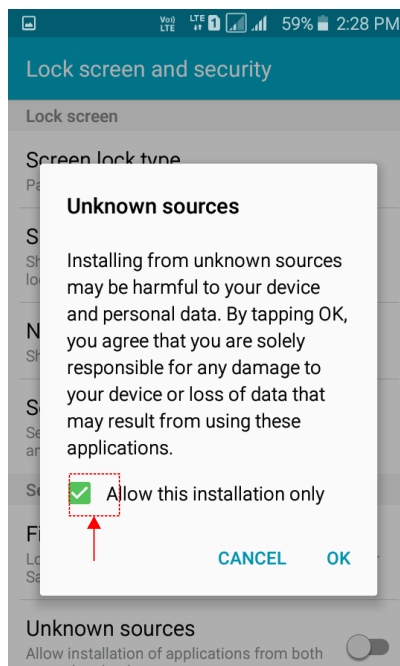

(Fig. 5.4)

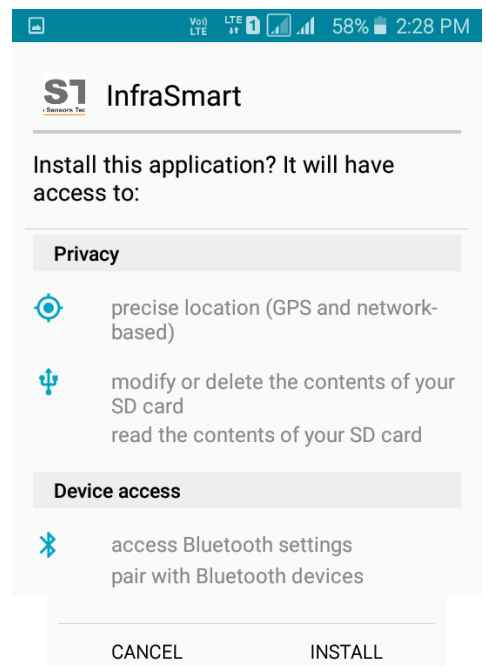

(Fig. 5.5)

5.2 Communication

After installation, switch on Bluetooth of mobile. Scan for available devices. (Fig. 5.6)

Select the device name from list for pairing. (Fig. 5.7)

For pairing user need to enter pin no. Pin no will be reverse of last four digit of device name.(For eg:- if device name is A2B-1627 then pin will be 7261). (Fig. 5.8)

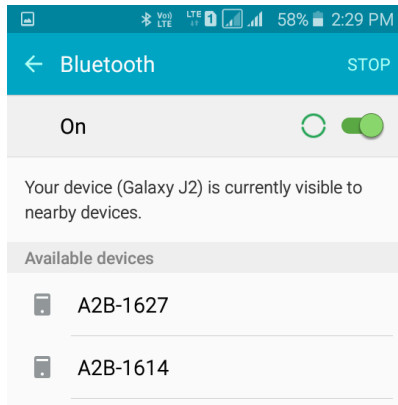

(Fig. 5.6)

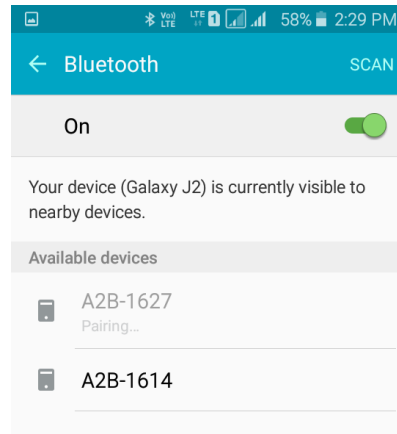

(Fig. 5.7)

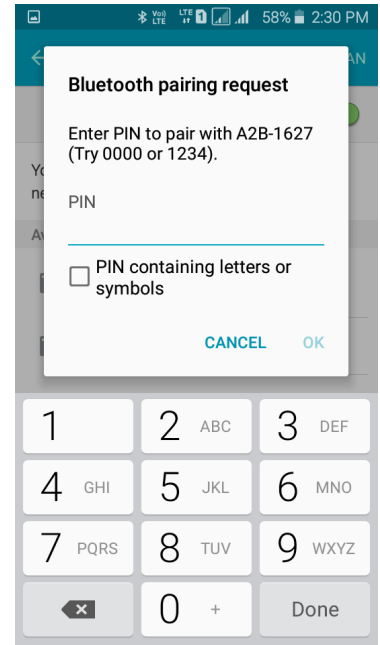

(Fig. 5.8)

Note: - Pairing require only one time until and unless it is not unpaired.

5.3 Operation

Open the Infrasmart application. Screen will appear as below, it will show all the devices which are paired. Select the device you need to connect. (Fig. 5.9)

Next screen will show all parameters of connected pyrometer. (Fig. 5.10 (a))



(Fig. 5.9)

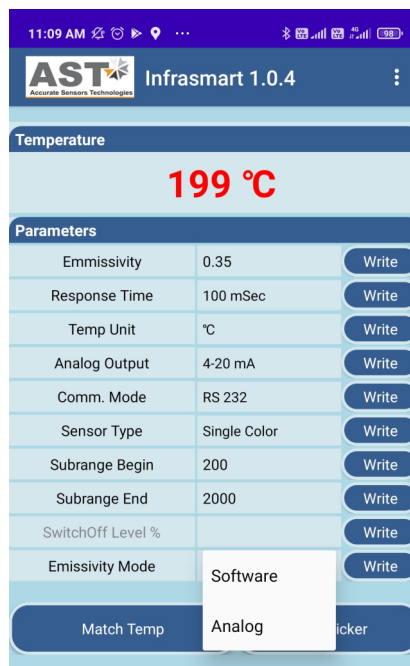

(Fig. 5.10 (a))

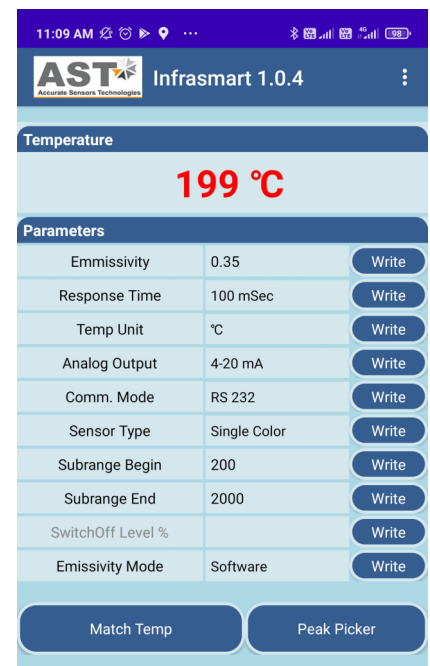

(Fig. 5.10 (b))

Note: - Don't click anywhere on screen until all data is loaded.

For parameter setting refer Page no 12 (4.2.3)

5.4 Data logging & Online graph

For data logging user need to click on dots which is at the right side as shown by arrow in below screen (Fig. 5.11) Next screen will be (Fig. 5.12)

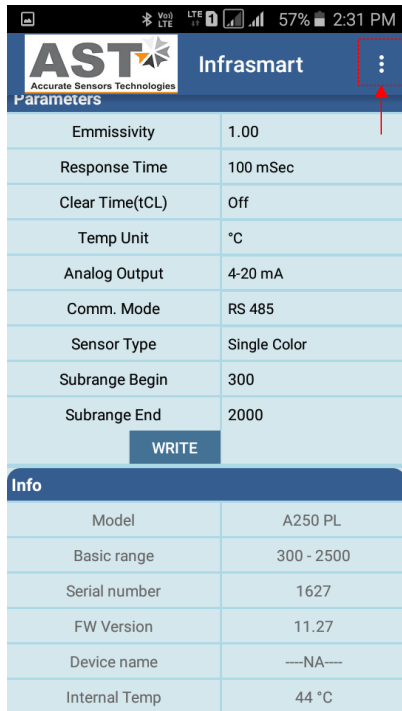

(Fig. 5.11)

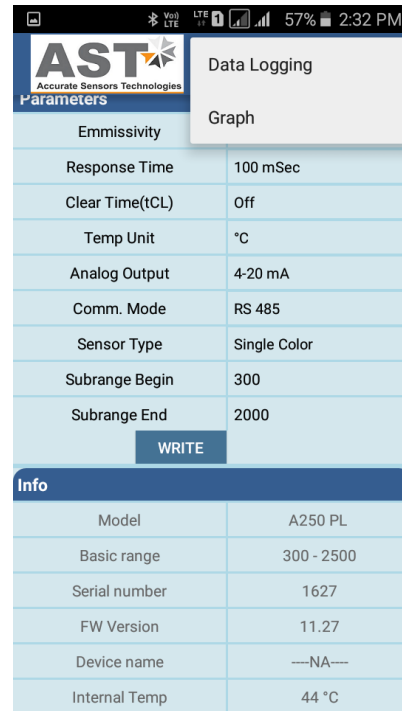

(Fig. 5.12)

For data logging click on data logging & to view online graph user can click on Graph(Fig. 5.13 & 5.14)

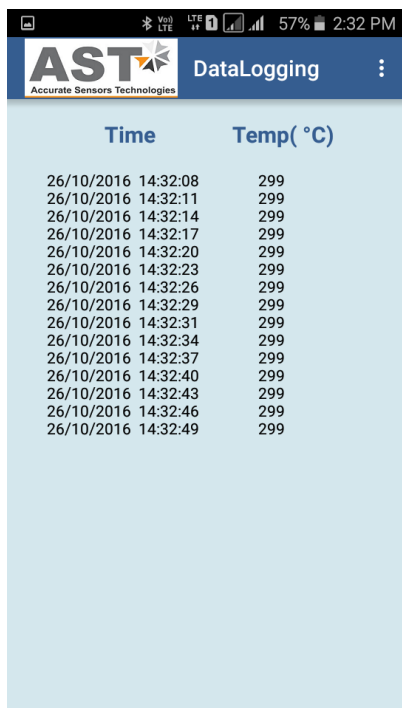

(Fig. 5.13)



(Fig. 5.14)

To Start data logging, Enter file name & log time then click on start tab.

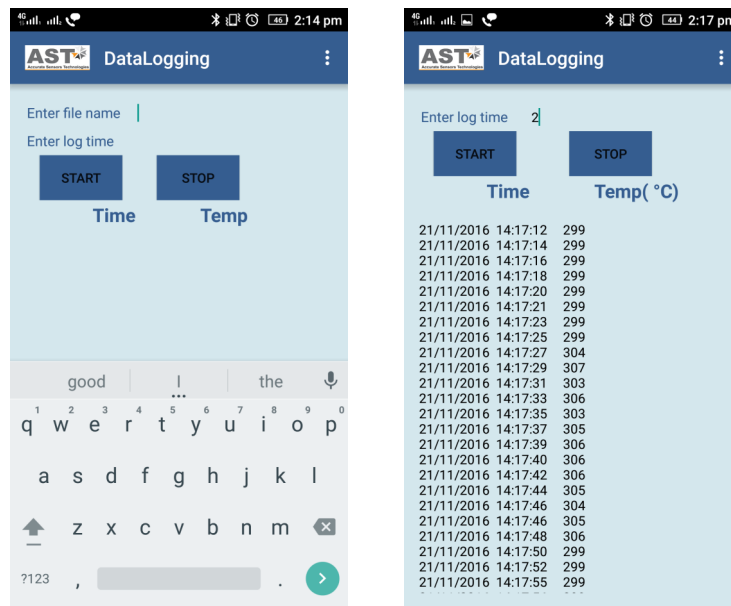

Note : If file name or log time is not enter within 5 sec then time out error will appear.

To save data logging click on save button.

Location where file is saved will be shown on data logging screen as shown(Fig. 5.15).

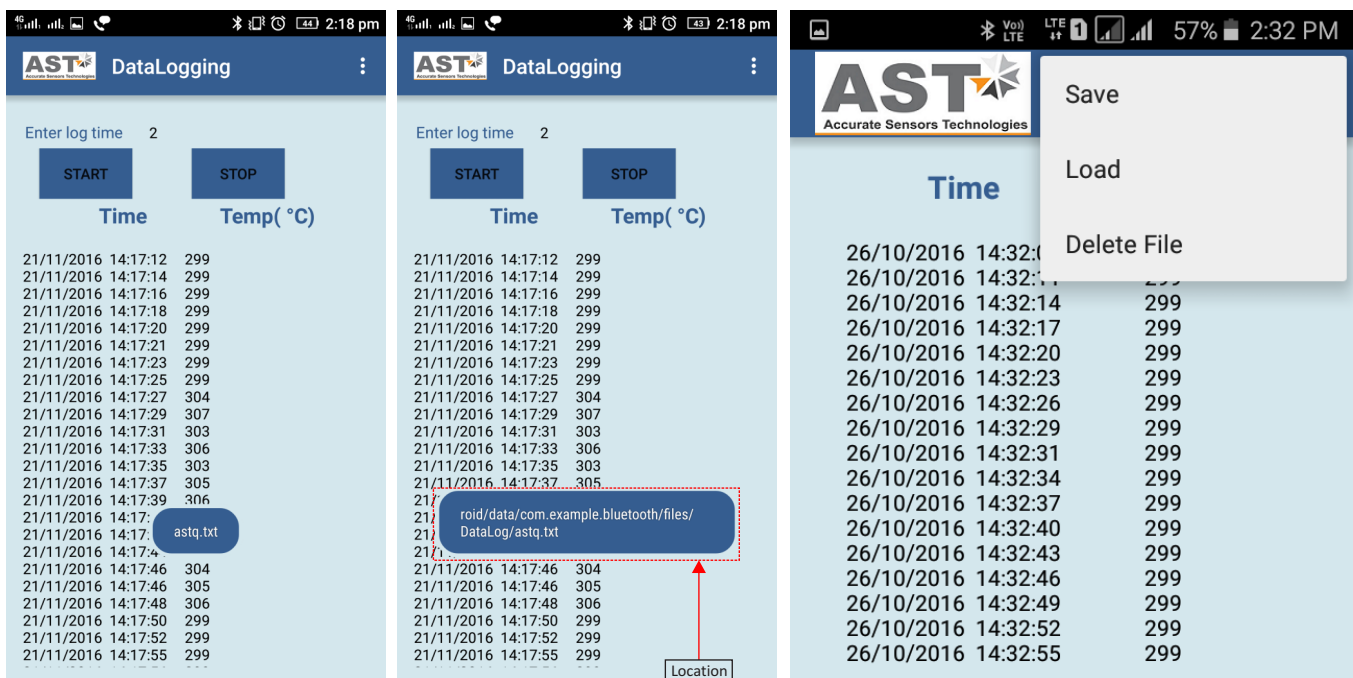

(Fig. 5.15)

To load file user need to enter file name

Basic Information Of Bluetooth

- Bluetooth Communication range is up to 5 meter in the line of site condition. Line of sight is a type of propagation that can transmit & receive data only where transmit & receive stations are in view of each other without any sort of an obstacle between them.
- Pyrometer works as a slave and mobile works as master.
- Pyrometer Bluetooth pair with multiple devices but can communicate with only single device at a time.

Chapter - 6

Calculate Spot Size

To calculate Spot Size click on **Utility** → **Calculate Spot Size**

This option is used to calculate the spot size at installed working distance of the Pyrometer. When you click on calculate spot size the new window will open.

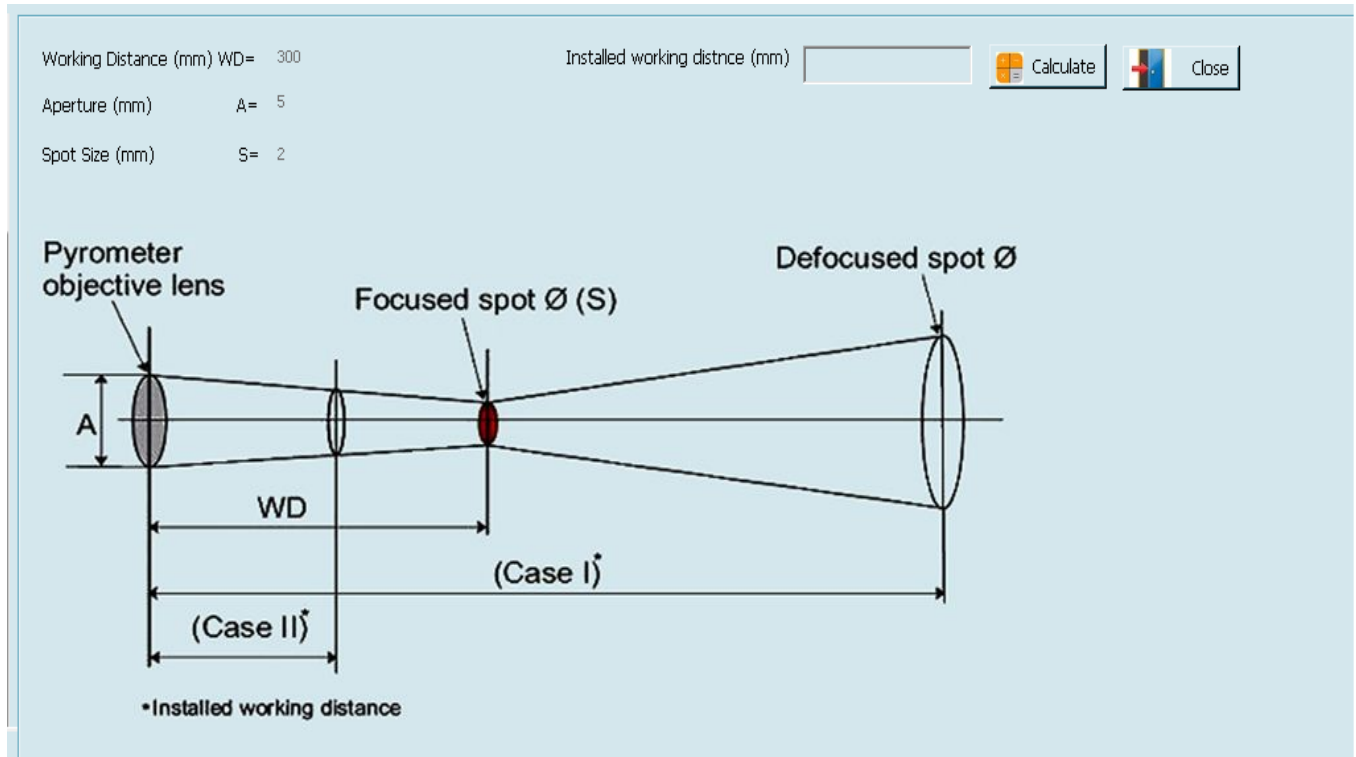

- WD = Manufactured working distance in (mm).**
- A = It shows the value of lens opening (Aperture in mm)**
- S = Manufactured spot size of the pyrometer (mm)**

User has to enter the value of WD, A, S, of the installed pyrometer (These values are given in section – 2.3). Now, putting the value of “Installed working distance” it will show the value of “Installed spot size”.

Chapter - 7

Maintenance

In case of any queries, questions regarding repair, solutions to problems, calibration and assistance you may contact our sales representatives. Most of problems can be solved telephonically.

7.1 Cleaning Lens

The lens should be kept clean all the time as it aims at center of target object. When cleaning lens care should be taken and it can be done as follows :

- Firstly blow off lightly loose particles with “canned air” which is used for cleaning computer equipment or a small bellows squeeze (used for cleaning lenses).
- Now brush out gently remaining particles with a soft hair brush, a soft lens tissue can also be used.
- At last clean remaining particles “dirt” using a cotton or soft lens tissue dampened in distilled water. Do not scratch the surface.

In case of finger prints or any other grease material uses any of the following removing elements:

- Kodak lens cleaner
- Ethanol
- Denatured alcohol

Gently wipe with a soft, clean cloth after application of any of the above elements and wipe until you are able to see colours on the surface, then allow to air dry.

Do not wipe the surface dry, as this may result in scratches on the surface.

Note: Do not use any cleaners containing ammonia or simple ammonia to wash or clean the optical lens of pyrometer as this may permanently damage the surface of lens.

Chapter - 8

Serial communication protocol-MT500

This protocol is developed to use in the half duplex addressable communication mode. Master device should periodically issue requests to each Slave device. The request contains an address of polling “Slave” device. Slave device reply only on the requests issued by Master. Each Slave has its own address to recognize the issued request. AST sensors always operate as Slave devices. Using RS485 serial communication option allows connecting more than one sensor to Master device. AST sensors always perform delay of 5 ms before sending an answer on Master request to meet RS485 hardware requirement.

MT500_AST protocol uses only RD (Batch Read) and WD (Batch Write) commands. Sending other MT500 protocol commands causes sensor to consider it as error condition and answer with unknown command reply. Symbols enclosed within apostrophes (‘symbol’) means ASCII representation of the symbols. String enclosed with quotation mark (“string”) means ASCII representation of the string (ended by ‘\0’). Data format is: 8 data bit, 1 stop bit, No parity, baud-rate 19200.

| Description | Address | Items | Parameters |
|------------------------------|---------|-------|--|
| Emissivity | '0400' | '01' | Object emissivity multiplied by 1000. Refer user manual for adjustable range. |
| Emissivity slope | '0401' | '01' | Emissivity slope parameter multiplied by 1000. Refer user manual for adjustable range. |
| Response time (τ) | '0105' | '01' | Parameter specifies analog and serial output response time. See Table 1. |
| Upper basic range | '0100' | '01' | Upper measurement range limit in °K (read only) |
| Lower basic range | '0101' | '01' | Lower measurement range limit in °K (read only) |
| Analog output type | '0F01' | '01' | '0000': 4 to 20 mA (Default); '0001': 0 to 20 mA, '0002': 0 to 10 Volt; '0003': K type TC; '0004': J type TC |
| Upper sub range | '0102' | '01' | Upper analog scale value in °K |
| Lower sub range | '0103' | '01' | Lower analog scale value in °K |
| Station number | '0200' | '01' | Adjustable between '0001' to '0255' |
| Temperature unit | '0201' | '01' | Flag is used to instruct PC SW to show temperature '0000': Centigrade (Default); '0001': Fahrenheit |
| Switch off level | '0107' | '01' | Parameter multiplied by 10. Adjusted between 0 and 100%, Default set to 15%. |
| Sensor mode | '0204' | '01' | '0000' = Single color; '0001' = Two color This parameter is useless for single color sensors. |
| Internal temperature | '0006' | '01' | Temperature inside device case in °C (read only) |
| Head temperature | '0007' | '01' | Temperature inside optical head m°C(only for E –series pyrometers) (read only) |
| Clear time(tCL) | '0303' | '01' | Adjustable between 0 to 12, Default 0, 0=OFF, 1=Auto. 2-12 = 10msec to 25sec [refer to page-13(clear time)] |
| Laser control | '0F00' | '01' | '0000': LASER OFF; '0001': LASER ON (Default) |
| Communication type selection | '0F03' | '01' | '0000':RS-485;; '0001': RS-232 (Default) |
| Set point | '1700' | '01' | Set point for relay actuation (only for E –series pyrometers) |
| Hysteresis | '1800' | '01' | Hysteresis value relay actuation |
| LCD back light control | '1801' | '01' | '0000': BL OFF; '0001': BL ON(Default) (Only for E-series pyrometers) |
| Device name | '1D00' | '01' | 10 Bytes “Hot end ”, if less then 10 bytes pad with space at end. |
| Working distance (mm) | '1D01' | '01' | 10 Bytes “1000 ”, if less then 10 bytes pad with space at end. |
| Spot size-aperture (mm) | '1D02' | '01' | 10 Bytes “1000-6000” if less then 10 bytes pad with space at end. '.' sign between spot size and aperture is compulsory |
| Relative energy (read only) | '0002' | '01' | Relative energy multiply by 1000 for 2 color pyrometers only |

| | | | |
|--|--------|------|--|
| Device model number (read only) | '0E00' | '01' | 10 bytes "AST450C ", if less than 10 byte pad with space at end |
| Firmware version | '1300' | '01' | Firmware version number of device (read only) |
| Sensor serial number (read only) | '1400' | '01' | 6 bytes in hex, if less than 6 bytes pad with '0' at start. Only numbers allowed. |
| Device type (read only) | '1301' | '01' | '0001': Single color; '0002' : Two color '0003': Thermopile; '0004' : Reserved |
| Real temperature and status code (read only) | '0000' | '02' | Calculated object temperature in °K and status of sensor (As shown in Appendix A). First process status code then real temperature. |

Batch Read (RD)command

| Byte 1 | Bytes 2,3 | Bytes 4, 5 | Bytes 6-9 | Bytes 10, 11 | Byte 12 | Bytes 13, 14 |
|--------|------------|------------|-----------|--------------|---------|--------------|
| 1 Byte | 2 Bytes | 2 Bytes | 4 Bytes | 2 Bytes | 1 Byte | 2 Bytes |
| STX | Station ID | RD | Address | Items | ETX | Checksum |

Byte 1: Always STX (0x02)

Bytes 2, 3: The Station Number of the device to read from (2 Hex digits)

Bytes 4, 5: The command to execute (RD)

Bytes 6-9: This is the starting address to read from. Must be 4 bytes long

Bytes 10, 11: This is the number of addresses (items) to read. Must be 2 bytes long

Byte 12: Always ETX (0x03)

Bytes 13, 14: The checksum is the lowest 8 bits of the sum of bytes 2 through 12

Example : Read two parameters starting from address 0000, from the station number 10 (0AH). This will read addresses 0000 and 0001.

| Byte 1 | Bytes 2, 3 | Bytes 4, 5 | Bytes 6-9 | Bytes 10, 11 | Byte 12 | Byte 13, 14 |
|--------|------------|------------|---------------------|--------------|---------|-------------|
| STX | 0A | RD | 0000 | 02 | ETX | 2E |
| 0x02 | 0x30, 0x41 | 0x52, 0x44 | 0x30,0x30,0x30,0x30 | 0x30, 0x32 | 0x03 | 0x32, 0x43, |

Checksum is calculated as the lowest 8 bits of the sum of the Hex codes for bytes 2 to 12.

Example : $70ARD\ 000002^1 + 0x30 + 0x41 + 0x52 + 0x44 + 0x30 + 0x30 + 0x30 + 0x30 + 0x30 + 0x32 + 3(ETX) = 22C \rightarrow$
Checksum is 2C lower byte of the result.

Reply

The reply length is $L = (N * 4) + 8$, Where N = the number of requested Items.

If the command is successful, the reply length will be at least 12 bytes. It consists of the STX, followed by four bytes for each requested item, then the ETX and Checksum.

| Byte 1 | Bytes 2, 3 | Bytes 4, 5 | Bytes 6-9 | Bytes 10-13 | Byte L-2 | Byte L-1, L |
|--------|------------|------------|-----------|-------------|----------|-------------|
| STX | Station | RD | Data 1 | Data N | ETX | Checksum |

Reply to above command if address '0000' contains value 1497 and address '0001' contains value 0000.

| Byte 1 | Bytes 2, 3 | Bytes 4, 5 | Bytes 6-9 | Bytes 10-13 | Byte 14 | Byte 15-16 |
|--------|------------|------------|---------------------|------------------------|---------|------------|
| STX | 0A | RD | 059D | 0000 | ETX | AC |
| 0x02 | 0x30, 0x41 | 0x52, 0x44 | 0x30,0x35,0x39,0x44 | 0x30, 0x30, 0x30, 0x30 | 0x03 | 0x41, 0x43 |

in the event of an error, the reply is

| Byte 1 | Byte 2, 3 | Byte 4, 5 | Byte 6 |
|--------|------------|------------|-----------------|
| NAK | 0A | 'R', 'D' | 01 (Error Code) |
| 0x15 | 0x30, 0x41 | 0x52, 0x44 | 0x30, 0x31 |

Batch Write (WD) command

| Byte 1 | Bytes 2, 3 | Bytes 4, 5 | Bytes 6-9 | Bytes 10, 11 | Bytes 12-15 | Bytes (L-6) - (L-3) | Byte L-2 | Byte L-1, L |
|--------|------------|------------|-----------|--------------|-------------|---------------------|----------|-------------|
| STX | Station ID | WD | Address | No. of Items | Data 1 | Data N | ETX | Checksum |

| Byte 1 | Bytes 2, 3 | Bytes 4, 5 | Bytes 6-9 | Bytes 10, 11 | Bytes 12-15 | Byte 16 | Byte 17,18 |
|--------|------------|------------|------------------------|------------------------|------------------------|---------|------------|
| STX | 0A | WD | 0400 | 01 | 03E8 | ETX | 74 |
| 0x02 | 0x30, 0x41 | 0x57, 0x44 | 0x30, 0x34, 0x30, 0x30 | 0x30, 0x31, 0x30, 0x30 | 0x30, 0x33, 0x45, 0x38 | 0x03 | 0x37, 0x34 |

Reply

If the command is successful, the reply is

| Byte 1 | Byte 2, 3 | Byte 4, 5 |
|--------|------------|------------|
| ACK | 0A | 'W', 'D' |
| 0x06 | 0x30, 0x41 | 0x57, 0x44 |

In the event of an error, the reply is

| Byte 1 | Byte 2, 3 | Byte 4, 5 | Byte 6 |
|--------|------------|------------|-----------------|
| NAK | 0A | 'W', 'D' | 01 (Error Code) |
| 0x15 | 0x30, 0x41 | 0x57, 0x44 | 0x30, 0x31 |

Error Codes

| Error Code | Description | Comments |
|------------|----------------------|---|
| '1' | Invalid check sum | See how to calculate a check sum |
| '2' | Unknown command | Protocol uses only RD (Batch Read) and WD (Batch Write) commands |
| '3' | Data length error | Number of items in WD (Batch Write) command doesn't match number of data bytes |
| '4' | ETX not found | ETX (0x03) not present in command |
| '5' | Illegal Address | number of items in a request is set to 0; memory segment number in a request is out of 0-25; Wrong command value, No data at requested address; |
| '6' | More items requested | More than 99 items were requested in command |
| '7' | Unsuccessful write | It informs Master that it should repeat WD command |

Table 1

| Tau (τ) | Analog Response Time, ms | Serial Response Time, ms |
|----------------|--------------------------|--------------------------|
| 1 | 2 | 20 |
| 3 | 6 | 50 |
| 5 | 10 | 100 |
| 10 | 20 | 200 |
| 30 | 60 | 300 |
| 50 | 100 | 500 |
| 100 | 200 | 1000 |
| 300 | 600 | 2000 |
| 500 | 1000 | 3000 |
| 1000 | 2000 | 4000 |
| 3000 | 6000 | 5000 |
| 5000 | 10000 | 10000 |

Appendix A

| DATA | Comments |
|-------------|---|
| Status code | '0000' : No error '0001' : Signal is lower than sensor sensitivity '0002' : Out of range due to T brightness minimum '0003' : Too low energy '0004' : Signal is higher than sensor sensitivity '0006' : Sharp brightness jump '0007' : Non stable object measurement '0011' : Internal temperature warning '0013' : Thermopile ambient temperature too low '0014' : Thermopile ambient temperature too high '0015' : Pyrometer in testing mode '0016' : Pilot light ON '0017' : Measurement below lower basic range '0018' : Measurement exceeds upper basic range '0019' : Pyrometer in warm up period |

Broadcast Message

WD (Batch Write) command with Station ID of 0 is considered as broadcast message. Sensors process this command regardless of their Station Number and do not issue replies.

It is useful when master issues a request to change the same parameters of more than one Slave devices.

For more information write us at, sales@astinfrared.com

Appendix B

Typical emissivity values for various materials available:

All the emissivity values shown in the table are only approximate, as it depends various parameters and it may affect the emissivity of a material. These parameters are as under:

1. Temperature
2. Thickness of material
3. Angle of measurement
4. Spectral range of measurement
5. Geometry
6. Surface quality (polished, rough , oxidized, sandblasted)
7. Transmission

| Material | Emissivity* |
|-----------------------------------|-------------|
| Aluminum, polished | 0.05 |
| Aluminum, rough surface | 0.07 |
| Aluminum, strongly oxidized | 0.25 |
| Asbestos board | 0.96 |
| Asbestos fabric | 0.78 |
| Asbestos paper | 0.94 |
| Asbestos slate | 0.96 |
| Brass, dull, tarnished | 0.22 |
| Brass, polished | 0.03 |
| Brick, common | 0.85 |
| Brick, glazed, rough | 0.85 |
| Brick, refractory, rough | 0.94 |
| Bronze, porous, rough | 0.55 |
| Bronze, polished | 0.10 |
| Carbon, purified | 0.80 |
| Cast iron, rough casting | 0.81 |
| Cast iron, polished | 0.21 |
| Charcoal, powdered | 0.96 |
| Chromium, polished | 0.10 |
| Clay, fired | 0.91 |
| Concrete | 0.54 |
| Copper, polished, | 0.01 |
| Copper, commercial burnished | 0.07 |
| Copper, oxidized | 0.65 |
| Copper, oxidized to black | 0.88 |
| Electrical tape, black plastic | 0.95 |
| Enamel ** | 0.90 |
| Formica | 0.93 |
| Frozen soil | 0.93 |
| Glass | 0.92 |
| Glass, frosted | 0.96 |
| Gold, polished | 0.02 |
| Ice | 0.97 |
| Iron, hot rolled | 0.77 |
| Iron, oxidized | 0.74 |
| Iron, sheet galvanized, burnished | 0.23 |
| Iron, sheet, galvanized, oxidized | 0.28 |
| Iron, shiny, etched | 0.16 |

| Material | Emissivity* |
|----------------------------|-------------|
| Iron, wrought, polished | 0.28 |
| Lacquer, Bakelite | 0.93 |
| Lacquer, black, dull | 0.97 |
| Lacquer, black, shiny | 0.87 |
| Lacquer, white | 0.87 |
| Lampblack | 0.96 |
| Lead, gray | 0.28 |
| Lead, oxidized | 0.63 |
| Lead, red, powdered | 0.93 |
| Lead, shiny | 0.08 |
| Mercury, pure | 0.10 |
| Nickel, on cast iron | 0.05 |
| Nickel, pure polished | 0.05 |
| Paint, silver finish** | 0.31 |
| Paint, oil, average | 0.94 |
| Paper, black, shiny | 0.90 |
| Paper, black, dull | 0.94 |
| Paper, white | 0.90 |
| Platinum, pure, polished | 0.08 |
| Porcelain, glazed | 0.92 |
| Quartz | 0.93 |
| Rubber | 0.93 |
| Shellac, black, dull | 0.91 |
| Shellac, black, shiny | 0.82 |
| Snow | 0.80 |
| Steel, galvanized | 0.28 |
| Steel, oxidized strongly | 0.88 |
| Steel, rolled freshly | 0.24 |
| Steel, rough surface | 0.96 |
| Steel, rusty red | 0.69 |
| Steel, sheet, nickelplated | 0.11 |
| Steel, sheet, rolled | 0.56 |
| Tar paper | 0.92 |
| Tin, burnished | 0.05 |
| Tungsten | 0.05 |
| Water | 0.98 |
| Zinc, sheet | |

Appendix C

Mechanical Drawings

1. Water Cooling Jacket

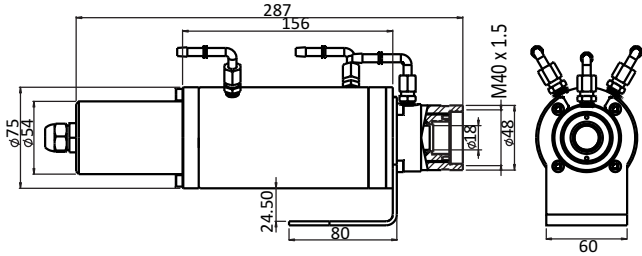

Water Cooling Jacket with Adjustable Flange PL
(Reference no: 8000-02)

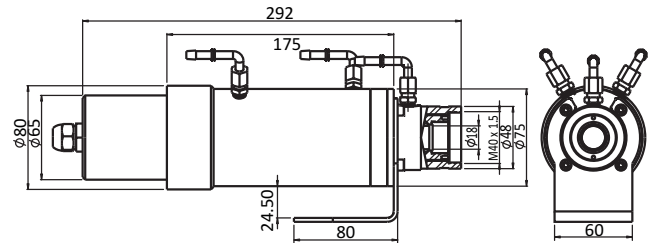

Water Cooling Jacket with Adjustable Flange TL
(Reference no: 8000-06)

2. Air Purge Unit

FOR 6 mm INSIDE
DIAMETER HOSE

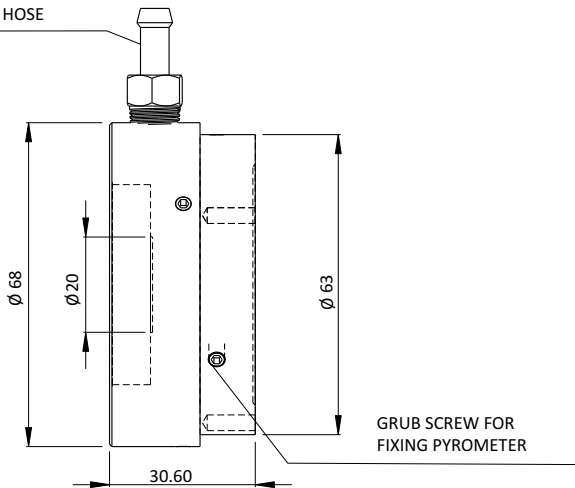

Air Purge Unit
(Reference no: 8000-04)

3. Adjustable Mounting Stand

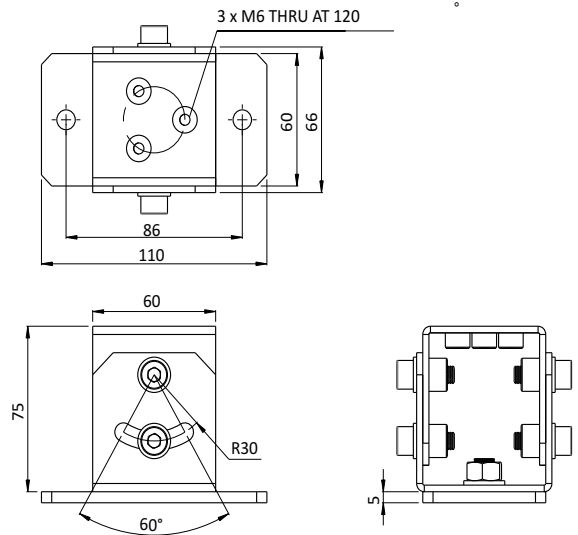

Adjustable Mounting Stand
(Reference no: 8000-07)

4. Mounting Clamp

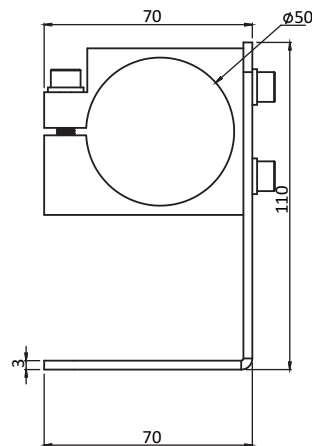

Mounting Clamp
(Reference no: 8000-05)

Information

Maintenance

The pyrometer has no internal parts, which have to be cleaned. The lens can be cleaned with compressed air, which is dry and free of oil. If the protection glass requires more thorough cleaning, use a soft, dry cloth such as that used to clean camera lenses.

Packing instructions

To transport or store the instrument, please use the original box or a box padded with sufficient shock absorbing material. For storage in humid areas or shipment overseas, the device should be placed in welded foil (ideally along with silicone gel) to protect it from humidity.

Warranty

AST A250 EM/A450 EM PL/TL instruments have a warranty of two years from the invoice date. This warranty covers manufacturing defects. User-induced faults are not covered under this warranty.

Software warranty

The windows compatible software was thoroughly tested on a wide range of windows operating systems. Nevertheless, there is always a possibility that windows or PC configuration or some other unforeseen condition exists that would cause the software not to run smoothly. The manufacturer assumes no responsibility or liability and will not guarantee the performance of the software. Liability regarding any direct or indirect damage caused by this software is excluded.

Limit of liability

AST not liable for any damages that arise from the use of any examples or processes mentioned in this manual.

Specifications are subject to change without notice

Copyright: © 2009, AST. All rights reserved.

This document may contain proprietary information and shall be respected as a proprietary document to AST with permission for review and usage given only to the rightful owner of the equipment with which this document is associated.

AST reserves the right to make changes, without further notice, to any products herein to improve reliability, function, or design. AST does not assume any liability arising out of the application or use of any product described herein, neither does it convey any license under its patent rights nor the rights of others.

Copyright: © 2009

ABOUT US

AST - Accurate Sensing Technologies

Accurate Sensing Technologies along with 3T - True Temperature Technologies established in 1994 focusing on the development and commercialization of non-contact temperature measurement technologies.

Based on these technologies, AST/3T has brought to the market a line of pyrometers for the remote measurement of target temperatures using no physical contact. AST/3T pyrometers use a totally new approach for remote temperature measurement achieving high accuracy.

The following products are available from AST/3T

- ❖ Single color pyrometer
- ❖ Ratio (2 color) pyrometer
- ❖ Fiber optics with single color and two color pyrometer
- ❖ Multi wavelength pyrometer specially for Aluminum & other Non - ferrous application
- ❖ Black Body calibration sources
- ❖ Special system for automatic Isothermal Extrusion (MOMAS)
- ❖ Parameter setting Devices



www.astinfrared.com

AST - Accurate Sensing Technologies

Misgav Industrial Park,
Misgav 20174, Israel
Ph. : +972-4-9990025, Fax. : +972-4-9990031
E-mail: info@accuratesensors.com

AST - Accurate Sensing Technologies

188A, B-169 (Part), B-188 (A),
Road No. - 5, Mewar Industrial Area, Udaipur
(Rajasthan) - 313003
Phone : +91-9352506032
Email : sales@astinfrared.com