



Accurate Sensors Technologies

**We measure accurate temperature in extreme conditions**

**AST P450C**

Non-contact Infrared Pyrometers

## **USER MANUAL**



**AST - Accurate Sensors Technologies**

Misgav Industrial Park, Misgav 20173, Israel

Tel: +972-4-9990025, Fax: +972-4-9990031

Email: [info@accuratesensors.com](mailto:info@accuratesensors.com)

Web: [www.accuratesensors.com](http://www.accuratesensors.com)



# Index

<b>1. Chapter - 1</b> .....	<b>1</b>
General information	
<b>2. Chapter - 2</b> .....	<b>2</b>
Introduction	
2.1 Application, range and working principle	
2.2 Technical specification	
2.3 Optical Data	
2.4 Standard Item Supplied with AST P450C	
<b>3. Chapter - 3</b> .....	<b>5</b>
Operation of the pyrometer	
3.1 Overview	
3.1.1 Adjustment of the diopter adaptor	
3.2 Installation of pyrometer	
3.2.1 Battery Insertion	
3.2.2 Switching On	
3.2.3 Display Function	
<b>4. Chapter - 4</b> .....	<b>9</b>
A. PCSoftware installation	
A. 4.1 Installation	
A. 4.2 Parameters in main screen	
A. 4.2.1 Communication	
A. 4.2.2 Parameter setting	
A. 4.2.3 Device information	
A. 4.3 Number of Events Present	
A. 4.4 Show Events	
A. 4.4.1 Data	
A. 4.4.2 Graph Mode	
A. 4.4.3 Numeric Mode	
A. 4.4.4 Save Events	
A. 4.5 Clear Memory	
<b>5. Chapter - 5</b> .....	<b>15</b>
Serial Communication Protocol MT500	

# Chapter - 1

## General Information

Congratulations on choosing this high quality and highly efficient AST pyrometer for non contact temperature measurement.

Please read this user manual carefully, step by step, including all notes of security, operation and maintenance before installing the pyrometer. This manual contains all the necessary instructions for set up and operation of the pyrometer. This section provides an overview about important safety regulations.

### **Some Important Safety Regulations Given Below:**

#### **1. Safety Precaution :**

Each person working with pyrometer must read the user manual before operation. The pyrometer has only to be used for the purpose described in manual. The pyrometer works only with a potential free low voltage. This voltage is not harmful for user. The pyrometer may contain harmful material and hence it should not be disposed of with normal waste.

#### **2. Packaging and Storage :**

Always use a shock proof package for shipment of pyrometer. It should be sealed to protect it against humidity. Also protect the lens of pyrometer with cover. They should be stored at the temperature range from -20°C to 55°C.

#### **3. Limit of Liability and Warranty**

All general information and notes for handling, maintenance and cleaning of this instrument are offered according to the best of our knowledge and experience.

AST reserves the right to revise this document and to make change from time to time in the content hereof without obligation to notify any person or persons of such revisions or changes. AST instruments have a warranty of two year from the invoice date. This warranty covers manufacturing defects and faults which arise during operation only if they are the results of defects caused by AST.

AST does not accept liability for any damages or losses which might occur, including consequential damages and financial losses, as a result of use of the instrument.

#### **4. Copyright :**

All rights reserved. This document may contain proprietary information and shall be respected as a proprietary document to AST with permission for review and usage given only to the rightful owner of the instrument with which this document is associated.

# Chapter - 2

## Introduction

AST P450C is specially designed highly accurate digital pyrometer to provide high performance and low maintenance of non contact temperature measurement in demanding industrial environment.

### 2.1 Application, Range and Working Principle

P450C are specially designed portable IR pyrometer for non contact temperature measurement between 210°C to 3000°C in demanding industrial environments. The Instruments feature high accuracy. The multi functional bright back light additional LCD graphic display panel provides an indication of status and configuration of pyrometer together with measurement mode. The measuring result is shown and can be analyzed directly on site.

The bright through the lens sighting gives a precise definition of the target spot.

The portable pyrometer provides fast, simple data logging with USB connectivity to download this data to PC for analysis. The fast response time within milliseconds allow exact measurement of fast moving object. The large data storage (data store up to 4000 values) of measurement offers the best possibility for analyzing the data.

#### The applications in which AST pyrometers can be used are:

- Welding
- Tempering
- Hardening
- Annealing
- Molten Glass
- Glass Moulds
- Steel
- Heater Tubes
- Reheat Furnaces

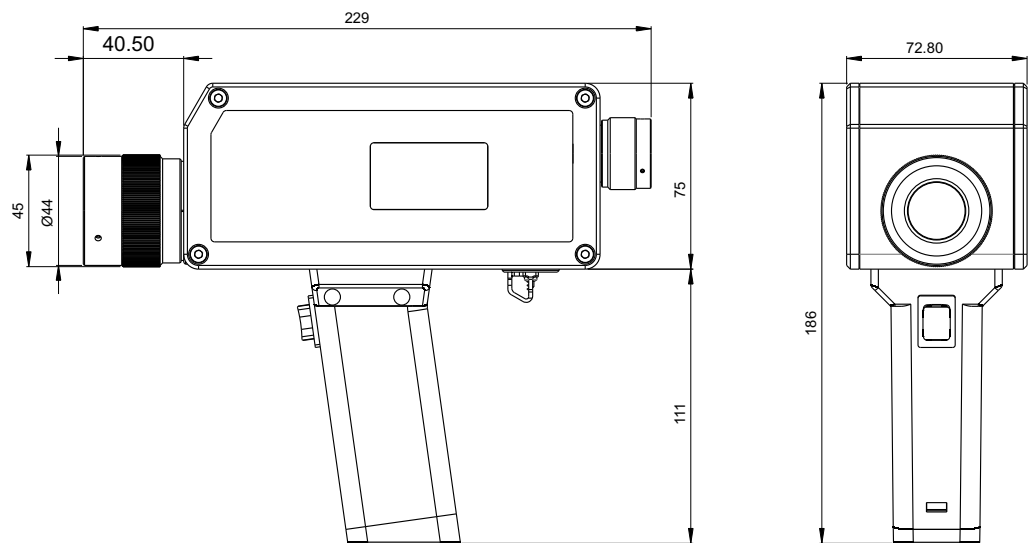

## 2.2 Technical Specifications

### Measurement Specifications

<b>Model</b>	<b>P450C</b>
Temperature Range	600°C....1600°C 800°C....2500°C
Spectral Range	0.8....1.1 μm, 0.9....1.1 μm
Photodetector Type	Si/Si
Distance to Spot Size Ratio	200:1 (600°C....1600°C) 400:1 (800°C....2500°C)
Emissivity (ε)	0.1....1.2 adjustable
Response Time	5 msec in Numerical Mode 10 msec in Graphical Mode 10 msec (When data storage is 'ON')
Accuracy	± 0.3% of the measured value + 1°C
Repeatability	0.1% of reading in °C + 1°C
Sighting Options	Optimized through lens view finder with dioptre correction -2.5 dpt. to +2.5 dpt
Objective	Achromatic, adjustable from A=500 mm to 9000 mm Effective lens aperture diameter D:16mm (distance 9000mm) to 21 mm (distance 500mm)
Measuring Functions	Normal (Normal Temperature Measurement) MAX (Maximum Temperature Measurement) AVG (Average Temperature Measurement)
Parameters Setting Via Side Keypad	Emissivity, Peak Picker(Clear Time)(tCL), Average, Storage Interval, Temperature Unit(°C/°F), Auto Off Time, Date, Time
Data Storage	4000 Values, Storage of Measurement Value, Date, Time, Emissivity
Storage Interval	OFF, 10 msec, 20 msec, 100 msec, 1 sec, 10 sec, 100 sec, 500 sec
Display	Left side: LCD Display, 128 x 64 pixels illuminated 3 value per sec.; last value is displayed for another 10 sec after finishing measurement (Hold Function) Additional Built in LED display in the view finder
Resolution	LED inside : 0.1°C upto 1000°C after this 1°C LCD outside : 0.1°C upto 1000°C after this 1°C
Serial Interface	USB 2.0
Alarm	Visual (LCD Blinking Facility)
Mounting	Tripod

### Physical Characteristics

Dimensions	228 x 64 x 186 mm (L x W x H)
Weight	900g with batteries
Housing	Aluminum, Handle: ABS

### Environmental Specification

Ambient Temperature	0 to 50°C
Storage Temperature	-20 to 55°C
Relative Humidity	10 - 95%, Non-Condensing Conditions
Protection Class	IP52(Housing Exclude Handle with battery case), IP40 (Handle)

### Electrical Specifications

Power Supply	3 x 1.2 V Rechargeable Batteries (uninterrupted operation time approx. 10 hours with rechargeable batteries)
CE Label	According to EU Directives about electromagnetic immunity

### Standard Item supplied with AST P450C :-

- Pyrometer with through the lens sighting.
- USB interface, USB 2.0 Cable.
- Calibration certificate.
- Software CD and Operation manual.
- Carry Box
- Charger

### 2.3 Optical Data

1) **Sighting** :- The bright through the lens sighting with spot indicator for precise targeting and built in temperature display facilities provide good target accuracy. If user want to focus view finder which is equipped with adjustable diopter adaptor then diopter adaptor can be adjust from min(0.5) to max ( $\infty$ )by rotating it.

2) **Spot Size Table** :- The objective can be focused to adjust within distances between 0.5m & infinity ( $\infty$ )

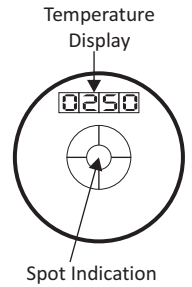

Measuring Distances MD (mm) with standard focusable optics	Spot Sizes(mm)	
	P450C 600°C - 1600°C (200:1)	P450C 800°C - 2500°C (400:1)
500	2.5	1.25
1000	5	2.5
2000	10	5
3000	15	7.5
4000	20	10
5000	25	12.5
9000	45	22.5

The pyrometers are equipped with a high quality focusable optics. Adjusting the optics to required measuring distance achieves the spot sizes specified in table. The adjustment can be taken via the scale on the objective or by focusing the measuring object in the view finder. User can adjust measuring distance from 500mm - infinity ( $\infty$ ).

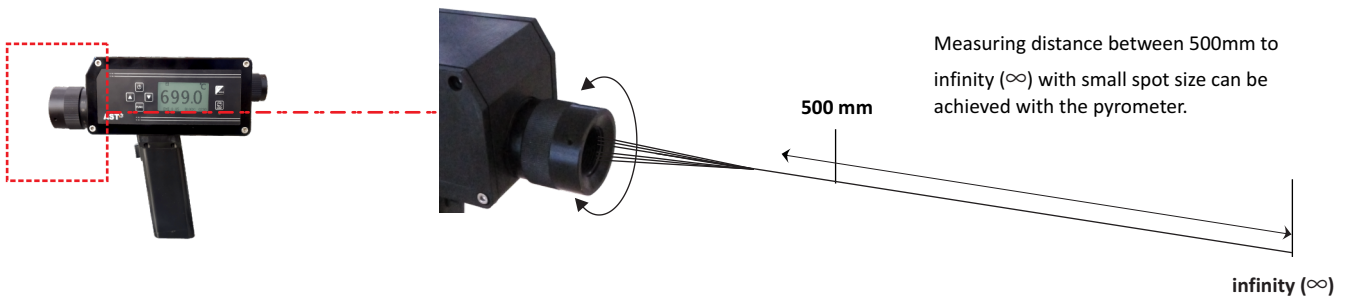

### 2.4 Standard Item supplied with AST P450C

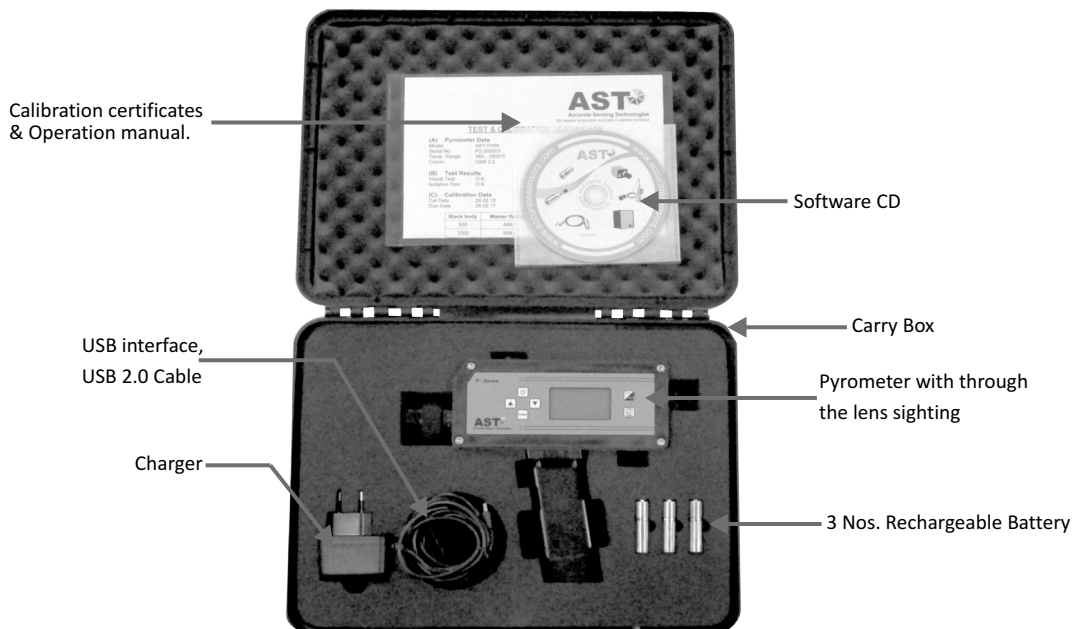

# Chapter - 3

## Operation of the Pyrometer

### 3.1 Overview

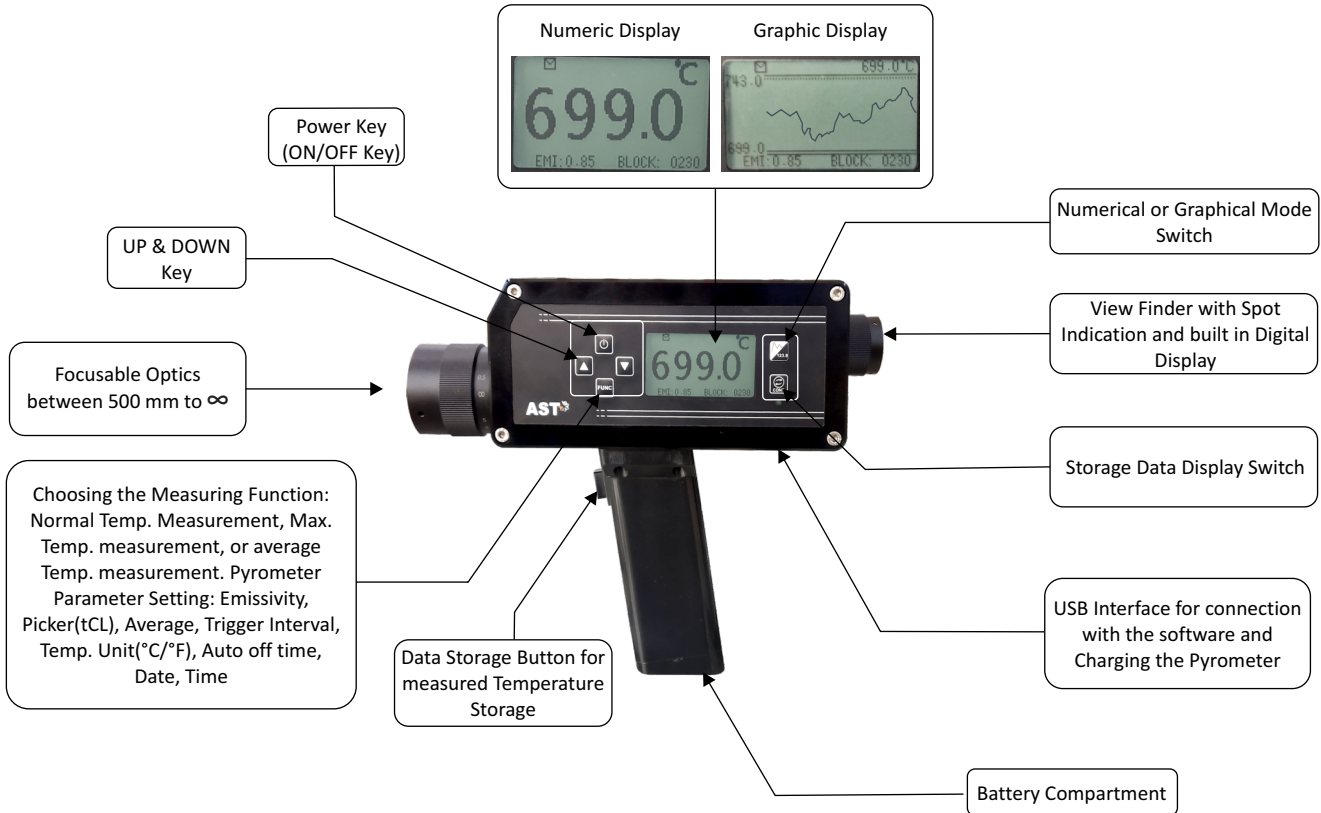

#### 3.1.1 Adjustment of the Diopter adaptor

The view finder is in-built with an adjustable diopter adaptor. The diopter adjuster has no visual zero position and has to be adjusted individually. It has to be adjusted for user to user.

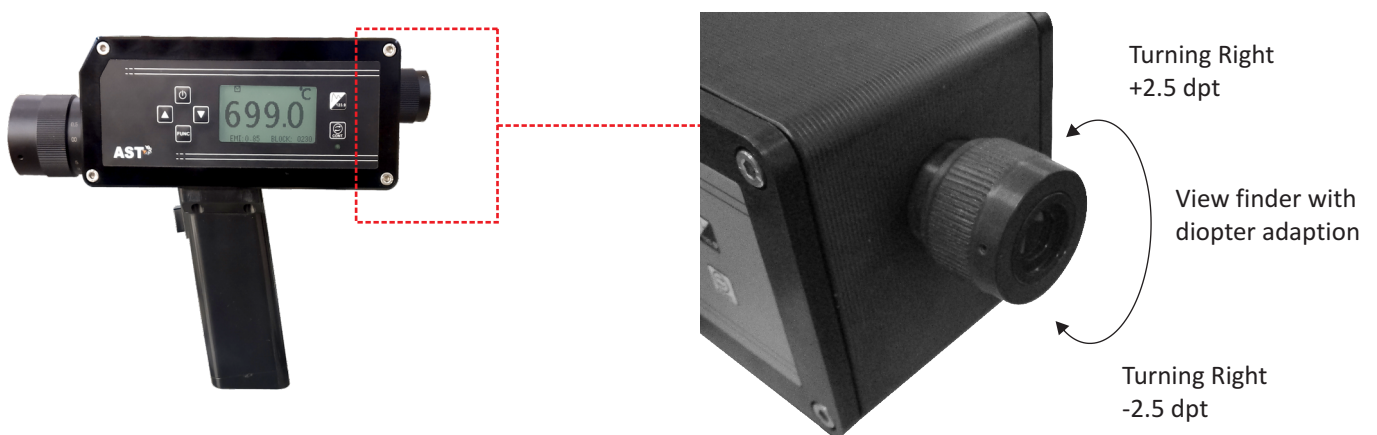



## 3.2 Installation of Pyrometer

### 3.2.1 Battery Insertion

For operating the pyrometer 3 batteries (rechargeable batteries) are required (Note :- Alkaline- manganese batteries should not be used). They must be inserted into the battery holder (Note:- polarity of battery should be correct). And installed afterward into the pyrometer handle (Note :- position and direction of battery should be correct). After closing the battery case cover the pyrometer is ready for use. The direction of battery holder shown in figure.

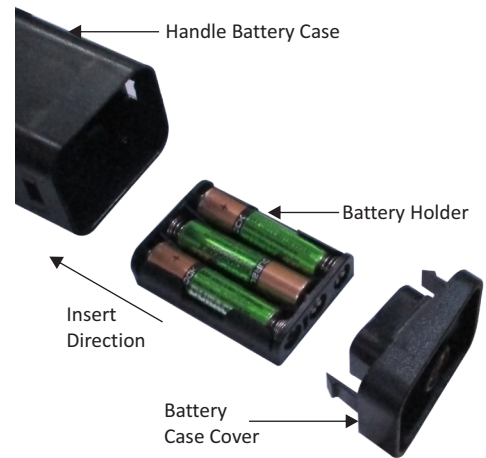

### 3.2.2 Switching ON

The pyrometer can be switched ON/OFF by pressing power key. Power key can be short press for ON and long press for OFF. After switching ON, the pyrometer immediately starts measurement. The result of the measurement is shown on LCD as well as in view finder.

**(A) Triggering point/ Single value storage:** - User will trigger the button on handle to hold the value, the value will automatically save into the pyrometer according to time interval.

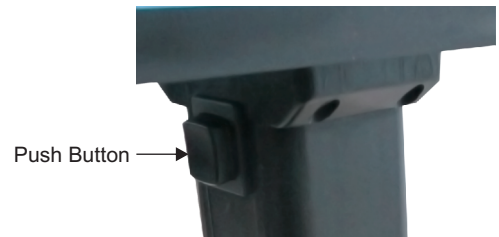

**(B) Multiple value storage :-** When push button pressed repeatedly for some time, then multiple measured values are stored in memory of pyrometer.

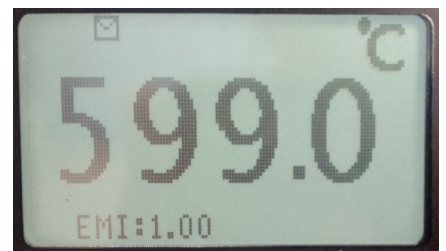

**(C) Continuous measurement/Continuous value storage :-** While pressing continuous key in LCD shows CONT., pyrometer will continuously start tracing the value. The tracing indication will shows on LCD display

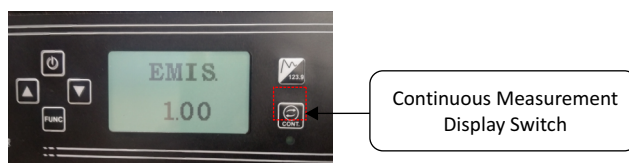
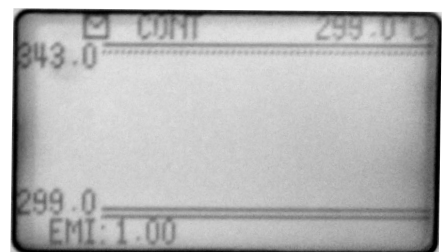

**(D) USB Interface :-** The pyrometer is equipped with a USB interface which can be connected with PC. The battery can be charge through USB interface by connecting to charger provided.

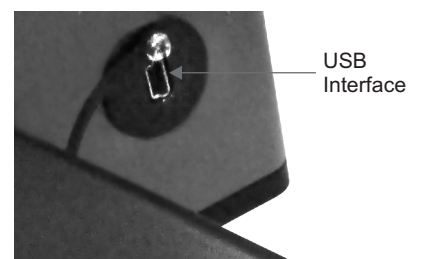

**Note :** Before start taking measurement pyrometer must be fully charge. The time of full charging of battery is 1.5 hour.

### 3.2.3 Display Functions

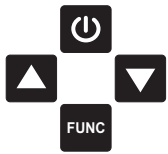

The pyrometer is controlled by adjustment button on left side of instruments.

**Function key :-** There are different uses of function key first one, this key is use to see different parameters in device and other one is set the value of parameter which is adjusted by UP & DOWN key. By pressing of Func Push button brings up the following functions one after other. They are appears in the bottom left of the LCD display in short form.



Function key adjustable parameters are below.



**A) Color Mode:** This parameter is used to select color modes (Single or Two color).

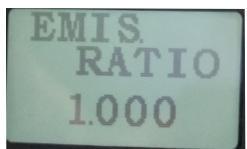

**B) Emissivity Ratio:** It is the relationship between the emissions of a real object and the emission of a black Body radiation source at the same

temperature. For a correct measurement it is necessary to adjust Emissivity. This parameter can be ranges from 0.1 to 1.2.

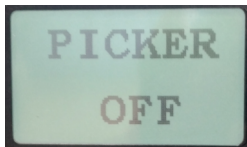

**C) Picker :-** User can calculate a maximum "peak" temperature value from specified number store real

temperature in the sensor memory. User can either ON or OFF the picker.

(for more details Refer 4.2.2(C))

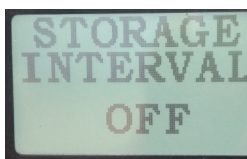

**D) Storage Interval :-** Interval determines whether only one value will be stored when push button is pressed up-to the single triggering point.

User can set storage interval from 10ms to 500 Sec.



**E) Response Time:** The response time can be set from 20 msec to 10sec when interval time is OFF. Response time takes the value same from Interval

time when interval is ON and set to specific value.

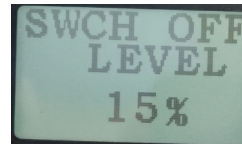

**F) Switch Off Level:** The switch of level is the function that is used to avoid measurement errors caused by signals, which are too low. Although factory default is set to 15%, the switch off limit can be adjusted between 1 and 100%. This function is useful in environment of heavy dust and obstacles so that pyrometer is able to read in case of very low energy signals.

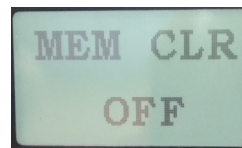

**G) Memory clear :-** To clear the save data from memory, memory clear function is used. By making memory clear

function ON, Memory can be cleared.

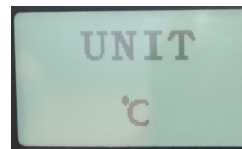

**H) Temperature Unit :-** User can select °C or °F unit.

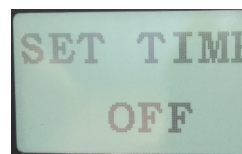

**I) Set Date & time :-** User can set correct date and time using this parameter. To get Access to the menu for date &

time keep pressing the FUNC button repeatedly.

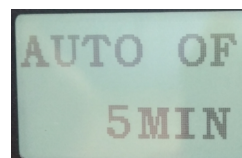

**J) Auto Off :-** User can set auto off time of pyrometer from 5mins. to 30mins. In this mode the pyrometer will

automatically off when no key is press in the time of Auto Powered OFF. Example if user set 5 minutes in Auto Off then the pyrometer will automatically Powered OFF if no key is press for 5 minutes.



**Up/ Down Key :-** These key is use to change the present value of any parameter (which given in function key) either upward or downward.



**Graphic /Numeric key :-** This key is used switch the display either graphical to numerical and Vice-versa.

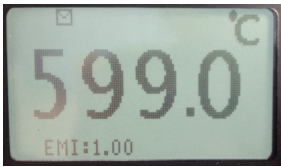

**A) Numeric Mode :-** In this measurement mode the display always show the current measured value, as well as set Emissivity.

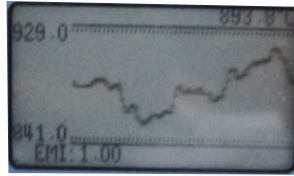

**B) Graphic Mode :-** In graphic mode temperature is shown graphically. In addition to the information in the numeric display, the maximum & minimum values are also shown. The relevant Maximum & Minimum value defines the scaling of Y-axis. The measurement curve runs in the direction of the X-axis. Each measured value represent by one pixel.

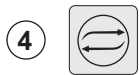

**Continuous Key :-** The pyrometer can also be used in continuous Measurement mode. To do this, after the pyrometer switched ON press the “CONT” push button. In continuous data saving mode Auto Off function will not work. To go back to normal measuring mode again press continues button, It shows Hold on screen and after 10 seconds goes back to normal measuring mode.



**NOTE :-** When the continuous Push button press continuously for 5 sec then the stored values shown on LCD display with all required parameters like date& time, emissivity, storage block etc. User can also view these stored values in graphical or numerical mode by pressing graphical/ numerical key.

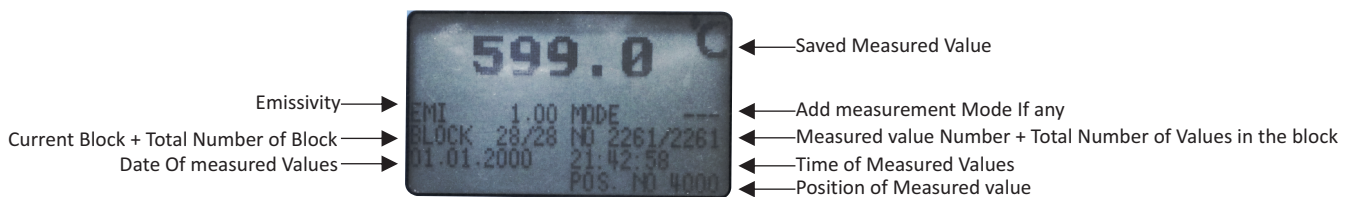

### Mode of Operation

- 1) **Normal measuring mode :** This mode is used for normal temperature measurement.(Refer to 3.2.3.3 A)
- 2) **Average measuring mode :** when average mode is ON then LCD of device will show average temperature after every 3sec (Refer to 3.2.3.3 D)
- 3) **Maximum measuring mode :** when peak picker is ON then LCD of device will show Max. temperature. (refer to 3.2.3.3 B)

# Chapter - 4

## A. PC Software Installation

The provided AST software offers possibilities to connect pyrometer for parameter Setting, offline graph and to evaluate measuring data.

### A. 4.1 Installation

Install the pyrometer software using the installation guide file on CD ROM. After installation of the software restart the computer and double click on application, it will open software screen.

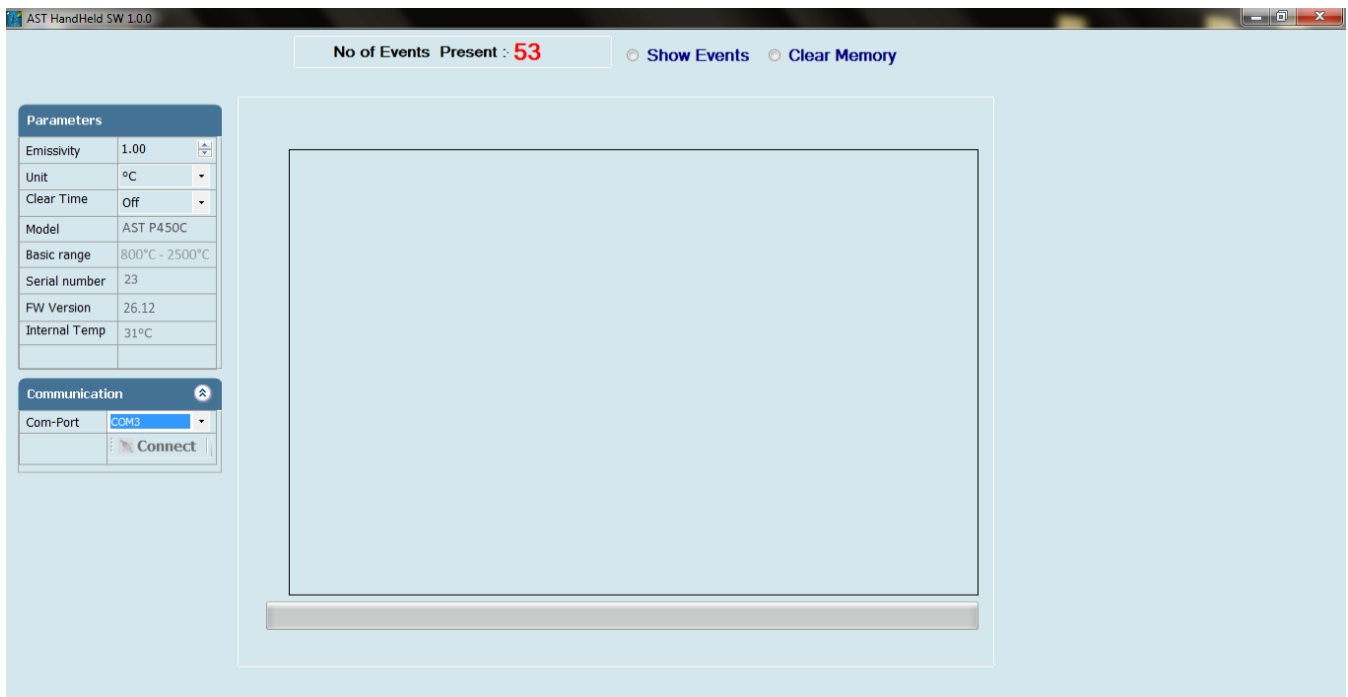

### A. 4.2. Parameters in main screen

#### A. 4.2.1 Communication

Communication between the AST pyrometer and the software is implemented via USB cable connected between the pyrometer and the PC USB port. This enables the acquisition and recording of data, as well as the transfer of commands from the software application to the AST pyrometer. Communication can be done by clicking on "Communication panel" and select correct COM Port where pyrometer is connected. Then click on CONNECT Button.

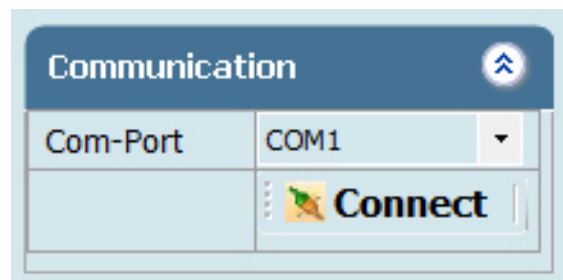

### A. 4.2.2 Parameter Setting

All user selectable device parameters can be set by using the software in the Panel "Parameter".

Parameters	
Emissivity	1.00
Unit	°C
Clear Time	OFF
Model	AST P450C
Basic range	800°C - 2500°C
Serial number	1
FW Version	26.12
Internal Temp	30°C

**A) Emissivity settings :** The emissivity can be set by clicking on "Parameters" and select or type in the desired emissivity directly in the description field. The emissivity value will be transferred to pyrometer by hitting the "TAB" button. The emissivity range is from 0.1 to 1.0.

For a correct measurement it is necessary to adjust the emissivity. This emissivity is the relationship between the emission of a real object and the emission of a black body radiation source at the same temperature. Different materials have different emissivities ranging between 0% and 100%. The major parameters effecting emissivity are:

1. The surface condition of the material, Rough surfaces have higher emissivities.
2. The spectral range of the pyrometer and the measuring temperature.
3. The Pyrometer spot size is fully filled by measured object or not.
4. The optical losses due to any obstruction in between pyrometer & measured object like glass window.

The emissivity setting of the pyrometer has to be adjusted accordingly. The tolerance of the emissivity values for each material is mainly dependent on the surface conditions.

**(B)Unit :** User can change the measuring unit of temperature from "Centigrade" to "Fahrenheit" and vice versa.

**(C)Clear time (tCL) :** if the peak picker is switched on, the highest last temperature value will always be displayed and stored. As such, it may be beneficial to periodically clear and reset the stored values in order to obtain new temperature readings. This feature is particularly useful when object temperature is not uniform across its dimension or the pyrometer is not constantly viewing an object to be measured. The peak picker works on two buffer memory to find maximum value over a defined interval. With the first memory, the highest measured value is held and is deleted alternately in the time interval set (clear time). The other memory retains the maximum value throughout the next time interval. The disadvantages of fluctuations in the display with the clock frequency are thereby eliminated.

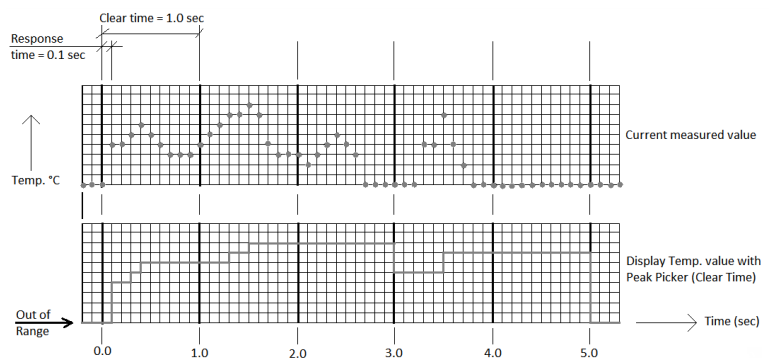

**Note:** The maximum value storage coincides with adjustments made to response time. Therefore:

- (i) Clear time ≤ the adjusted response time is useless
- (ii) Clear times must be at least 5 times longer than the response time.
- (iii) Only maximum with full maximum value can be recorded, which appear at least 5 times longer than response time.

The following setting is possible:

**OFF :** At clear time "OFF" the maximum value storage is switched OFF and only momentary values are measured.

**10msec...25sec :** Any clear time between 10msec and 25sec (please refer to Note (ii) above) when set, estimates the maximum values and holds it in two buffer memory. After the entered time, the storage will be deleted.

**Auto :** “Auto” mode is used for discontinuous measuring task, such as object being transported on a conveyor belt in such a case the maximum value for each object has to be indicated. When the object passes the measuring beam of the pyrometer, the maximum value is stored until a new hot object appears in the measuring beam. The temperature which has to be recognized as “hot” is defined by the low limit of the adjusted sub range. The stored maximum value will be deleted when the temperature of the new hot object exceeds the low limit “from” of the sub range by at least 1°C. If a lower limit is not entered, the maximum value storage will be deleted whenever the low level of the full measuring has been exceeded.

**Note :** Remaining all parameters are inactive & non changeable.

#### A. 4.2.3 Device Information

Model	AST P450C
Basic range	800°C - 2500°C
Serial number	1
FW Version	26.12
Internal Temp	30°C

#### A. 4.3 Number of Events present

In this feature all number of events are display in numeric mode which is stored in pyrometer. The maximum number of events is store in pyrometer up to 4000.

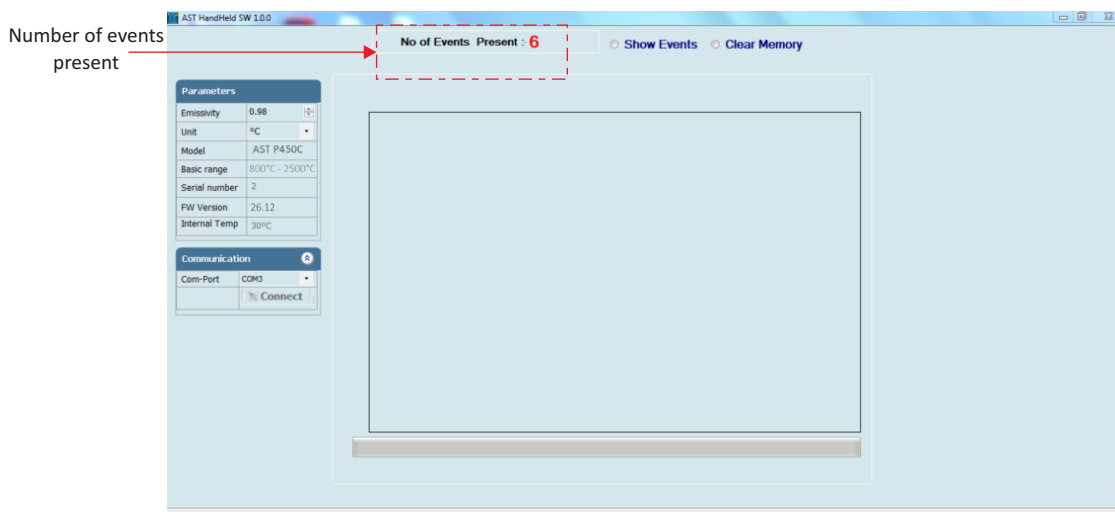

#### A. 4.4 Show Events

When user click on this feature all number of blocks which are store in pyrometer, shown on main screen. Each number of blocks contain many number of events. User finds all block numbers as well as the block start time, stop time, date & number of events which is store in particular block number on the screen.

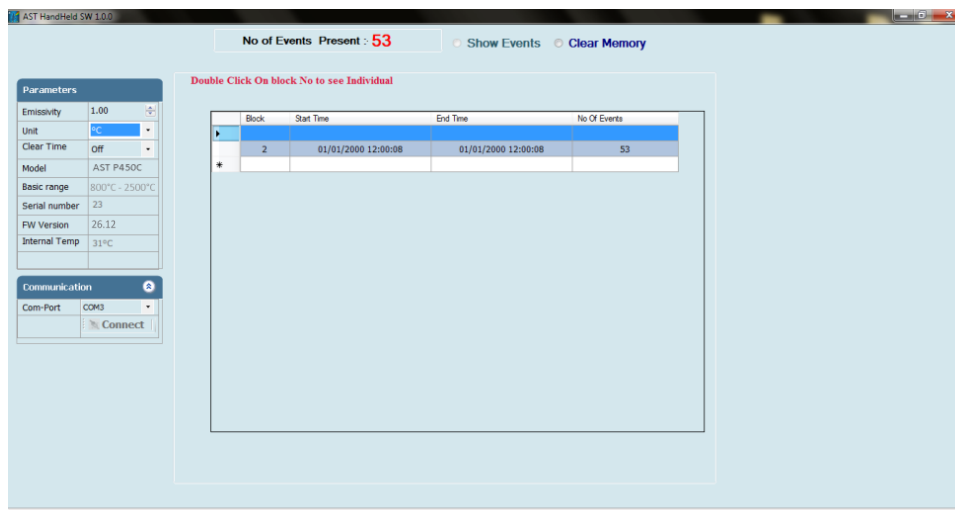

### A. 4.4.1 Data

To see particular block data click on particular block number. All the data of this block shown on screen, this particular block contain all events, Date, time, temperature and emissivity.

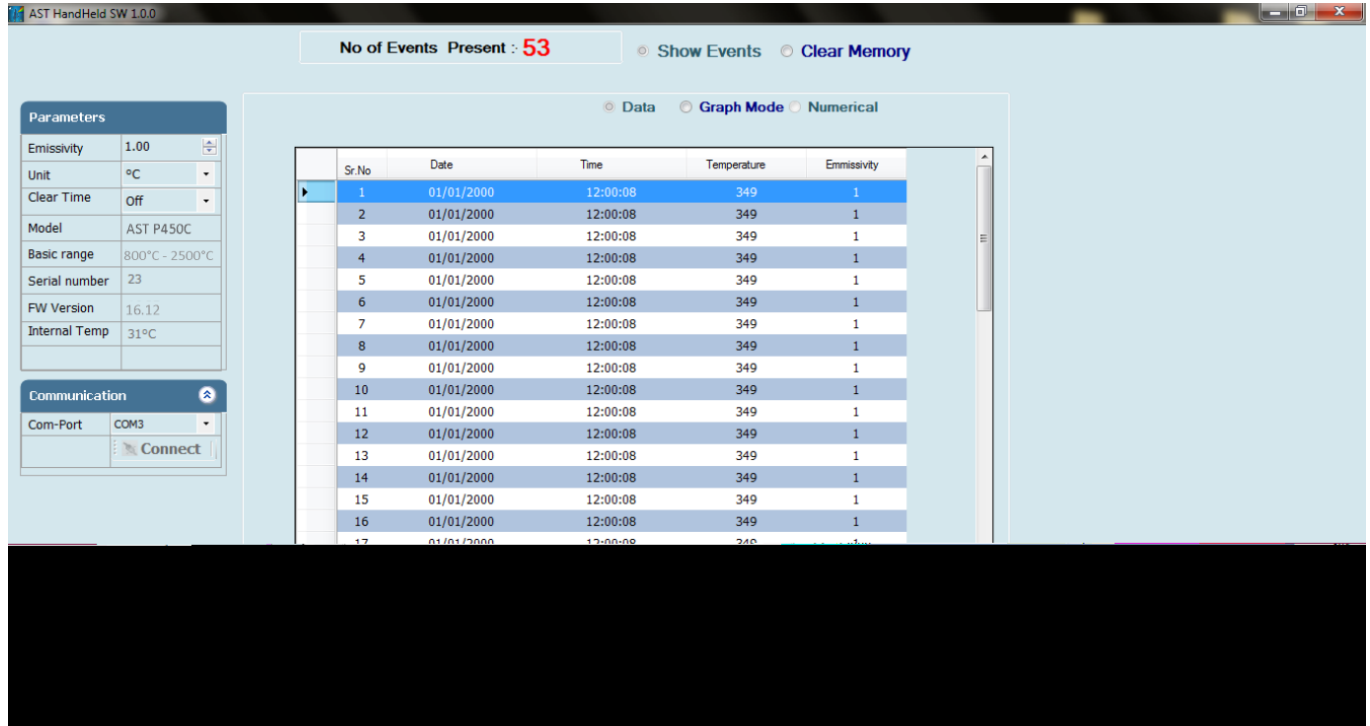

### A. 4.4.2 Graph Mode

To see particular block data graphically, user can click on graph mode. Graph mode's X axis denotes time scale & Y axis denotes temperature scale.

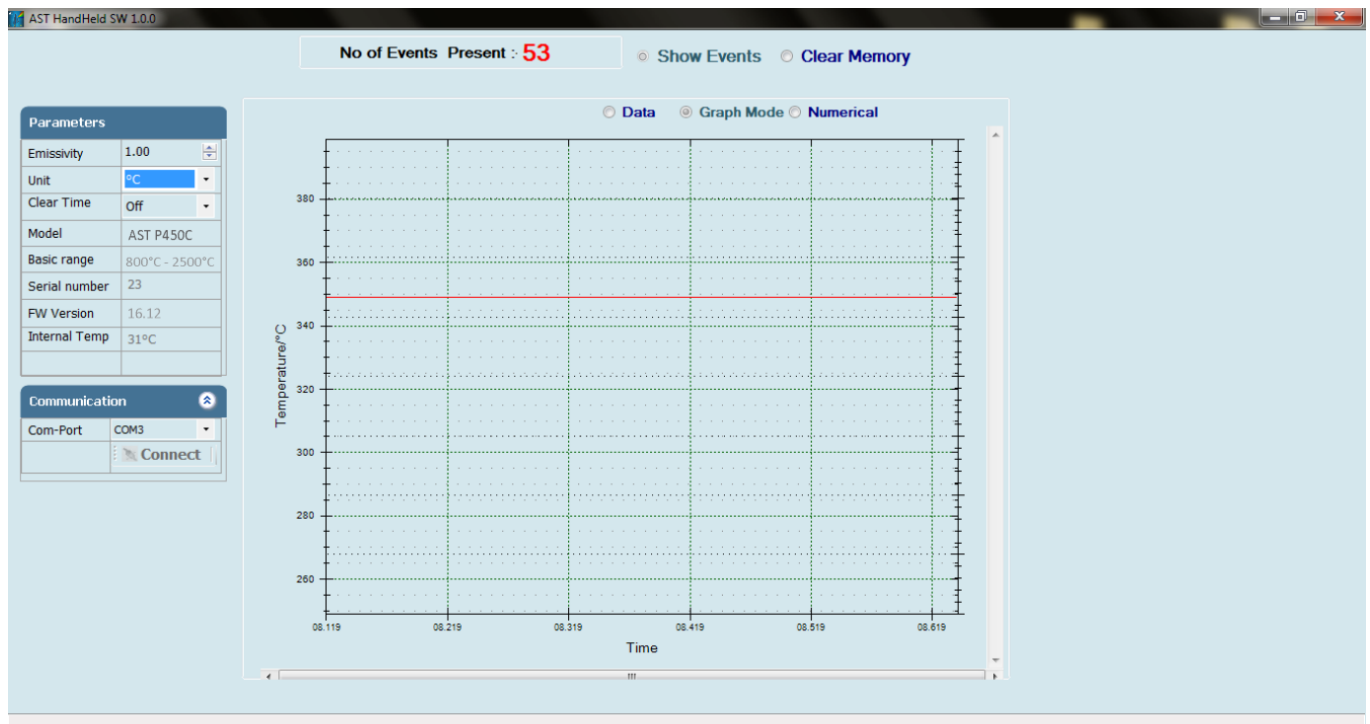

### A. 4.4.3 Numeric Mode

To see particular block data numerically, user can click on numeric mode. The data in this particular block contain all events, time, temperature and emissivity.

AST HandHeld SW 1.0.0

No of Events Present : **53**     Show Events     Clear Memory

Data     Graph Mode     Numerical

**Parameters**

Emissivity	1.00
Unit	°C
Clear Time	Off
Model	AST P450C
Basic range	800°C - 2500°C
Serial number	23
FW Version	26.12
Internal Temp	31°C

**Communication**

Com-Port: COM3   

Sr.No	Date	Time	Temperature	Emmissivity
1	01/01/2000	12:00:08	349	1
2	01/01/2000	12:00:08	349	1
3	01/01/2000	12:00:08	349	1
4	01/01/2000	12:00:08	349	1
5	01/01/2000	12:00:08	349	1
6	01/01/2000	12:00:08	349	1
7	01/01/2000	12:00:08	349	1
8	01/01/2000	12:00:08	349	1
9	01/01/2000	12:00:08	349	1
10	01/01/2000	12:00:08	349	1
11	01/01/2000	12:00:08	349	1
12	01/01/2000	12:00:08	349	1
13	01/01/2000	12:00:08	349	1
14	01/01/2000	12:00:08	349	1
15	01/01/2000	12:00:08	349	1
16	01/01/2000	12:00:08	349	1
17	01/01/2000	12:00:08	349	1
18	01/01/2000	12:00:08	349	1
19	01/01/2000	12:00:08	349	1

### A. 4.4.4 Save Events

To save particular block, user can click on save events. After clicking on save events, a pop-up appears on screen. The name of file and location is user defined. The format of file is “.xls” & user can not change it.

AST HandHeld SW 1.0.0

No of Events Present : **53**     Show Events     Clear Memory

Data     Graph Mode     Numerical     Save Events

**Parameters**

Emissivity	1.00
Unit	°C
Clear Time	Off
Model	AST P450C
Basic range	800°C - 2500°C
Serial number	23
FW Version	26.12
Internal Temp	31°C

**Communication**

Com-Port: COM3   

Sr.No	Date	Time	Temperature	Emmissivity
1	01/01/2000	12:00:08	349	1
2	01/01/2000	12:00:08	349	1
3	01/01/2000	12:00:08	349	1
4	01/01/2000	12:00:08	349	1
5	01/01/2000	12:00:08	349	1
6	01/01/2000	12:00:08	349	1
7	01/01/2000	12:00:08	349	1
8	01/01/2000	12:00:08	349	1
9	01/01/2000	12:00:08	349	1
10	01/01/2000	12:00:08	349	1
11	01/01/2000	12:00:08	349	1
12	01/01/2000	12:00:08	349	1
13	01/01/2000	12:00:08	349	1
14	01/01/2000	12:00:08	349	1
15	01/01/2000	12:00:08	349	1
16	01/01/2000	12:00:08	349	1
17	01/01/2000	12:00:08	349	1
18	01/01/2000	12:00:08	349	1
19	01/01/2000	12:00:08	349	1





# Chapter - 5

## Serial communication protocol-MT500

This protocol is developed to use in the half duplex addressable communication mode. Master device should periodically issue requests to each Slave device. The request contains an address of polling “Slave” device. Slave device reply only on the requests issued by the Master. Each Slave has its own address to recognize the issued request. AST sensors always operate as Slave devices. Using RS485 serial communication option allows connecting more than one sensor to Master device. AST sensors always perform delay of 5 ms before sending an answer on Master request to meet RS485 hardware requirement.

MT500\_AST protocol uses only RD (Batch Read) and WD (Batch Write) commands. Sending other MT500 protocol commands causes sensor to consider it as error condition and answer with unknown command reply. Symbols enclosed within apostrophes (‘symbol’) means ASCII representation of the symbols. String enclosed with quotation mark (“string”) means ASCII representation of the string (ended by ‘\0’). Data format is: 8 data bit, 1 stop bit, No parity, baud-rate 19200.

Description	Address	Items	Parameters
Emissivity	'0400'	'01'	Object emissivity multiplied by 1000. Refer user manual for adjustable range.
Emissivity slope	'0401'	'01'	Emissivity slope parameter multiplied by 1000. Refer user manual for adjustable range.
Upper basic range	'0100'	'01'	Upper measurement range limit in °K (read only)
Lower basic range	'0101'	'01'	Lower measurement range limit in °K (read only)
Station number	'0200'	'01'	Adjustable between '0001' to '0255'
Temperature unit	'0201'	'01'	Flag is used to instruct PC SW to show temperature '0000': Centigrade (Default); '0001': Fahrenheit
Switch off level	'0107'	'01'	Parameter multiplied by 10. Adjusted between 0 and 100%, Default set to 15%.
Sensor mode	'0204'	'01'	'0000' = Single color; '0001' = Two color This parameter is useless for single color sensors.
Internal temperature	'0006'	'01'	Temperature inside device case in °C (read only)
Clear time(tCL)	'0303'	'01'	Adjustable between 0 to 12, Default 0, 0=OFF, 1=Auto. 2-12 = 10msec to 25sec [refer to page-13(clear time)]
Communication type selection	'0F03'	'01'	'0000':RS-485,, '0001': RS-232 (Default)
LCD back light control	'1801'	'01'	'0000': BL OFF; '0001': BL ON(Default) (Only for E-series pyrometers)
Device name	'1D00'	'01'	10 Bytes “Hot end ”, if less then 10 bytes pad with space at end.
Working distance (mm)	'1D01'	'01'	10 Bytes “1000 ”, if less then 10 bytes pad with space at end.
Spot size-aperture (mm)	'1D02'	'01'	10 Bytes “1000-6000” if less then 10 bytes pad with space at end. '-' sign between spot size and aperture is compulsory
Relative energy (read only)	'0002'	'01'	Relative energy multiply by 1000 for 2 color pyrometers only

Device model number (read only)	'0E00'	'01'	10 bytes "AST450C ", if less than 10 byte pad with space at end
Firmware version	'1300'	'01'	Firmware version number of device (read only)
Sensor serial number (read only)	'1400'	'01'	6 bytes in hex, if less than 6 bytes pad with '0' at start. Only numbers allowed.
Device type (read only)	'1301'	'01'	'0001': Single color; '0002' : Two color '0003': Thermopile; '0004' : Reserved
Real temperature and status code (read only)	'0000'	'02'	Calculated object temperature in °K and status of sensor (As shown in Appendix A). First process status code then real temperature.

### Batch Read (RD)command:

Byte 1	Bytes 2,3	Bytes 4, 5	Bytes 6-9	Bytes 10, 11	Byte 12	Bytes 13, 14
1 Byte	2 Bytes	2 Bytes	4 Bytes	2 Bytes	1 Byte	2 Bytes
STX	Station ID	RD	Address	Items	ETX	Checksum

Byte 1: Always STX (0x02)

Bytes 2, 3: The Station Number of the device to read from (2 Hex digits)

Bytes 4, 5: The command to execute (RD)

Bytes 6-9: This is the starting address to read from. Must be 4 bytes long

Bytes 10, 11: This is the number of addresses to read. Must be 2 bytes long

Byte 12: Always ETX (0x03)

Bytes 13, 14: The checksum is the lowest 8 bits of the sum of bytes 2 through 12

**Example :** Read two parameters starting from address 0000, from the station number 10 (0AH). This will read addresses 0000 and 0001.

Byte 1	Bytes 2, 3	Bytes 4, 5	Bytes 6-9	Bytes 10, 11	Byte 12	Byte 13, 14
STX	0A	RD	0000	02	ETX	2E
0x02	0x30, 0x41	0x52, 0x44	0x30,0x30,0x30,0x30	0x30, 0x32	0x03	0x32, 0x43,

Checksum is calculated as the lowest 8 bits of the sum of the Hex codes for bytes 2 to 12.

### Reply:

The reply length is  $L = (N * 4) + 8$ , Where N = the number of requested Items.

If the command is successful, the reply length will be at least 12 bytes. It consists of the STX, followed by four bytes for each requested item, then the ETX and Checksum.

Byte 1	Bytes 2, 3	Bytes 4, 5	Bytes 6-9	Bytes 10-13	Byte L-2	Byte L-1, L
STX	Station	RD	Data 1	Data N	ETX	Checksum

Reply to above command if address '0000' contains value 1497 and address '0001' contains value 0000.

Byte 1	Bytes 2, 3	Bytes 4, 5	Bytes 6-9	Bytes 10-13	Byte 14-15
STX	0A	RD	059D	0000	9C
0x02	0x30, 0x41	0x52, 0x44	0x30,0x35,0x39,0x44	0x30, 0x30, 0x30, 0x30	0x39, 0x43

in the event of an error, the reply is

Byte 1	Byte 2, 3	Byte 4, 5	Byte 6
NAK	0A	'R', 'D'	01
0x15	0x30, 0x41	0x52, 0x44	0x30, 0x31

### Batch Write (WD) command

Byte 1	Bytes 2, 3	Bytes 4, 5	Bytes 6-9	Bytes 10, 11	Bytes 12-15	Bytes (L-6) - (L-3)	Byte L-2	Byte L-1, L
STX	Station ID	WD	Address	No. of Items	Data 1	Data N	ETX	Checksum

Byte 1	Bytes 2, 3	Bytes 4, 5	Bytes 6-9	Bytes 10, 11	Bytes 12-15	Byte 16	Byte 17,18
STX	0A	WD	0400	01	03E8	ETX	74
0x02	0x30, 0x41	0x57, 0x44	0x30, 0x34, 0x30, 0x30	0x30, 0x31, 0x30, 0x30	0x30, 0x33, 0x45, 0x38	0x03	0x37, 0x34

### Reply :

If the command is successful, the reply is

Byte 1	Byte 2, 3	Byte 4, 5
ACK	0A	'W', 'D'
0x06	0x30, 0x41	0x57, 0x44

In the event of an error, the reply is

Byte 1	Byte 2, 3	Byte 4, 5	Byte 6
NAK	0A	'W', 'D'	01
0x15	0x30, 0x41	0x57, 0x44	0x30, 0x31

**Error Codes:**

<b>Error Code</b>	<b>Description</b>	<b>Comments</b>
'1'	Invalid check sum	See how to calculate a check sum
'2'	Unknown command	Protocol uses only RD (Batch Read) and WD (Batch Write) commands
'3'	Data length error	Number of items in WD (Batch Write) command doesn't match number of data bytes
'4'	ETX not found	ETX (0x03) not present in command
'5'	Illegal Address	number of items in a request is set to 0; memory segment number in a request is out of 0-25; Wrong command value, No data at requested address;
'6'	More items requested	More than 99 items were requested in command
'7'	Unsuccessful write	It informs Master that it should repeat WD command

**Table 1:**

<b>Tau (<math>\tau</math>)</b>	<b>Analog Response Time, ms</b>	<b>Serial Response Time, ms</b>
1	2	20
3	6	50
5	10	100
10	20	200
30	60	300
50	100	500
100	200	1000
300	600	2000
500	1000	3000
1000	2000	4000
3000	6000	5000
5000	10000	10000

# Information

## Maintenance

The pyrometer has no internal parts, which have to be cleaned. The lens can be cleaned with compressed air, which is dry and free of oil. If the protection glass requires more thorough cleaning, use a soft, dry cloth such as that used to clean camera lenses.

## Packing instructions

To transport or store the instrument, please use the original box or a box padded with sufficient shock absorbing material. For storage in humid areas or shipment overseas, the device should be placed in welded foil (ideally along with silicone gel) to protect it from humidity.

## Warranty

AST P450C instruments have a warranty of two years from the invoice date. This warranty covers manufacturing defects. User-induced faults are not covered under this warranty.

## Software warranty

The windows compatible software was thoroughly tested on a wide range of windows operating systems. Nevertheless, there is always a possibility that windows or PC configuration or some other unforeseen condition exists that would cause the software not to run smoothly. The manufacturer assumes no responsibility or liability and will not guarantee the performance of the software. Liability regarding any direct or indirect damage caused by this software is excluded.

## Limit of liability

AST not liable for any damages that arise from the use of any examples or processes mentioned in this manual.

***Specifications are subject to change without notice***

Copyright: © 2009, AST. All rights reserved.

This document may contain proprietary information and shall be respected as a proprietary document to AST with permission for review and usage given only to the rightful owner of the equipment with which this document is associated.

AST reserves the right to make changes, without further notice, to any products herein to improve reliability, function, or design. AST does not assume any liability arising out of the application or use of any product described herein, neither does it convey any license under its patent rights nor the rights of others.

Copyright: © 2009



# ABOUT US

## AST - Accurate Sensors Technologies

Accurate Sensors Technologies along with 3T - True Temperature Technologies established in 1994 focusing on the development and commercialization of non-contact temperature measurement technologies.

Based on these technologies, AST/3T has brought to the market a line of pyrometers for the remote measurement of target temperatures using no physical contact. AST/3T pyrometers use a totally new approach for remote temperature measurement achieving high accuracy.

The following products are available from AST/3T

- ❖ Single color pyrometer
- ❖ Ratio (2 color) pyrometer
- ❖ Fiber optics with single color and two color pyrometer
- ❖ Multi wavelength pyrometer specially for Aluminum & other Non - ferrous application
- ❖ Black Body calibration sources
- ❖ Special system for automatic Isothermal Extrusion (MOMAS)
- ❖ Parameter setting Devices



[www accuratesensors.com](http://www accuratesensors.com)

### AST - Accurate Sensors Technologies

Misgav Industrial Park,  
Misgav 20174, Israel  
Ph. : +972-4-9990025, Fax. : +972-4-9990031  
E-mail: [info@accuratesensors.com](mailto:info@accuratesensors.com)

### AST - Accurate Sensing Technologies

188A, B-169 (Part), B-188 & B-189 (A)  
Road No.-5, M.I.A., Madri, Udaipur  
(Rajasthan.) INDIA 313 003  
Ph.: +91-294-3290271  
E-mail: [sales@accuratesensors.com](mailto:sales@accuratesensors.com)