



Accurate Sensors Technologies

**We measure accurate temperature in extreme conditions**

**AST E250/450 PL**

Non-contact Infrared Pyrometers

## **USER MANUAL**



**AST - Accurate Sensors Technologies**

Misgav Industrial Park, Misgav 20173, Israel

Tel: +972-4-9990025, Fax: +972-4-9990031

Email: [info@accuratesensors.com](mailto:info@accuratesensors.com)

Web: [www.accuratesensors.com](http://www.accuratesensors.com)

# Index

<b>1. Chapter - 1</b> .....	<b>1</b>
General information	
<b>2. Chapter - 2</b> .....	<b>2</b>
Introduction	
2.1 Application, range and working principle	
<b>3. Chapter - 3</b> .....	<b>3</b>
Technical specification	
<b>4. Chapter - 4</b> .....	<b>4</b>
Setting at the instrument	
4.1 Operation	
4.2 Adjustment parameters	
4.3 Connection diagram	
4.4 Pin assignment	
<b>5. Chapter - 5</b> .....	<b>7</b>
Optics	
5.1 Sensor head details	
5.2 Optical specification	
<b>6. Chapter - 6</b> .....	<b>8</b>
Accessories	
6.1 Electrical accessories	
6.2 Mechanical accessories	
<b>7. Chapter - 7</b> .....	<b>11</b>
Software installation	
7.1 Installation	
7.2 Parameter in main screen	
<b>9. Chapter - 8</b> .....	<b>18</b>
Calculate spot size	
<b>7. Chapter - 9</b> .....	<b>19</b>
Serial communication protocol	

# Chapter - 1

## General Information

We are pleased that you have chosen this high quality and highly efficient AST pyrometer for non-contact temperature measurement.

Please read this manual carefully, step by step before performing any operation with the Pyrometer. It contains all the necessary instructions for set up and operation of the pyrometer. When operating the instrument, it is necessary to follow the general safety instructions.

### 1.1 Safety Measures

This section provides an overview about important safety regulations.

#### 1.1.1 General

Each person working with the pyrometer must have read the user manual before operation. The Pyrometer has only to be used for the purpose described in the manual.

#### 1.1.2 Safety Precaution

The Pyrometer works only with a potential-free low voltage of range 24V DC. This voltage is not harmful for the user.

#### 1.1.3 Maintenance and use of Pyrometer

Pyrometer can be operated by the qualified person who has got instructions from the supervisor. It is strongly prohibited to do technical modifications of the device without permission of the manufacturer.

#### 1.1.4 Environmental Protection

The lens or its coating may contain harmful materials and hence it should not be disposed of with normal waste.

#### 1.1.5 Packaging and storage

Always use a shock-proof package for shipment of the pyrometer. It should be sealed to protect it against humidity. Also protect the lens of the pyrometer with a cover. They should be stored at the temperature ranges from -20° to +70° C.

#### 1.1.6 Warranty

AST E250/450 PL instruments have a warranty of two years from the invoice date. AST will replace defective parts, which arises from design errors or manufacturing faults. In case, if pyrometer is opened, disassembled or modified then the guarantees will loss.

AST does not accept liability for any damage or losses which might occur, including consequential damages and financial losses, as a result of use of the equipment.

#### 1.1.7 Copyright ©

© All rights reserved. This document may contain proprietary information and shall be respected as a proprietary document to AST with permission for review and usage given only to the rightful owner of the equipment with which this document is associated.

## Chapter - 2

### Introduction

AST E250/450 PL are specially designed highly accurate digital pyrometers with extended optical head, inbuilt LCD, LED light & keypad for parameterization to provide high performance and low maintenance of non contact temperature measurement in demanding industrial environment.

#### 2.1 Application, Range and Working Principle

The AST E250/450 PL pyrometers are especially designed for industrial purposes. They are suitable for high temperature measurement ranging from 250°C to 1900°C.

The AST E 250/450 PL are pyrometers with extended head and LED light. These instruments are equipped with a cable and an optical head. The cable & optical head are unaffected by electromagnetically interferences (e.g. induction) and can be used in ambient temperatures up to 70°C. The pyrometers are equipped with a display which shows in measuring mode the current temperature. Additionally all parameters can be read if they are changed via the integrated keys at the instrument. Via serial interface and the provided software the temperature can be displayed and stored on a PC, parametrizing can also be done.

AST E 250/450 PL has response time of 10 msec. It has USB 2.0 (RS-232 / RS-485 Optional) outputs. Instrument can be powered directly through USB without any external power supply. Emissivity, analog output sub range, response time and Peak Picker, relay output, analog outputs, selection can be preset ex works or adjusted through available optional software or via keypad.

The pyrometer temperature measurement method utilizes the fact that objects emit thermal radiation in an amount that directly corresponds to their own temperature and surface emissivity.

The pyrometer sensor detects the amount of infrared radiation emitted by the measured object (target). The infrared signal is analyzed and the temperature it represents is analyzed by built-in microprocessor.

#### The applications in which AST pyrometers can be used are:

- Induction heating
- Casting
- Annealing
- Welding
- Forging
- Sintering
- Melting
- Rolling
- Hardening etc...



## Chapter - 3

### Technical Specifications

Model	AST E250 PL	AST E450 PL
Measured Temperature Ranges (Analog sub range adjustable)	250° - 1000°C 300° - 1300°C 350° - 1800°C	600° - 1900°C
Spectral Range, $\mu\text{m}$	1.6 $\mu\text{m}$	1 $\mu\text{m}$
Photodetector Type	InGaAs	Si
Distance to spot size ratio	20 : 1 40 : 1 80 : 1	80 : 1
Response Time	10 msec. Adjustable upto 10 sec	
Accuracy	+/- 0.3% of the measured value +1° C	
Repeatability	0.1% of reading in °C +1°C	
Emissivity	0.1...1 adjustable	
Analog output	4-20 mA or 0-20m or 0-10 V User selectable	
Digital output	USB 2.0, [RS - 232 / RS - 485 (Optional)]	
Power	24V DC	
Resolution	0.1K	
Sighting	With LED light (Laser as optional)	
Operating temperature range	Electronic and optical head 0°C ...+70°C	
Relay Output (Optional)	Relay output with hysteresis 60V DC / 42V AC RMS, 0.4A	
Storage temperature	-20° .... +70°C	
Dimensions/Weight	112.50mm x 82.50mm x 33mm (l x w x h) / Weight = 600g	
Adjustable Parameters via Keypad/software	Emissivity, Analog output, Address, Response time, Peak picker, Analog output Sub range	

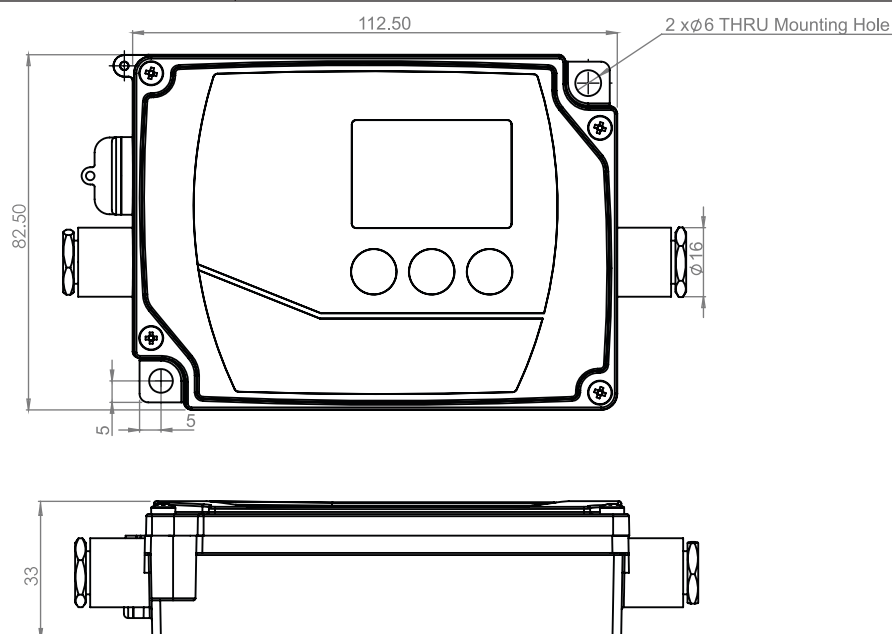

## Chapter - 4

### Setting at the instrument

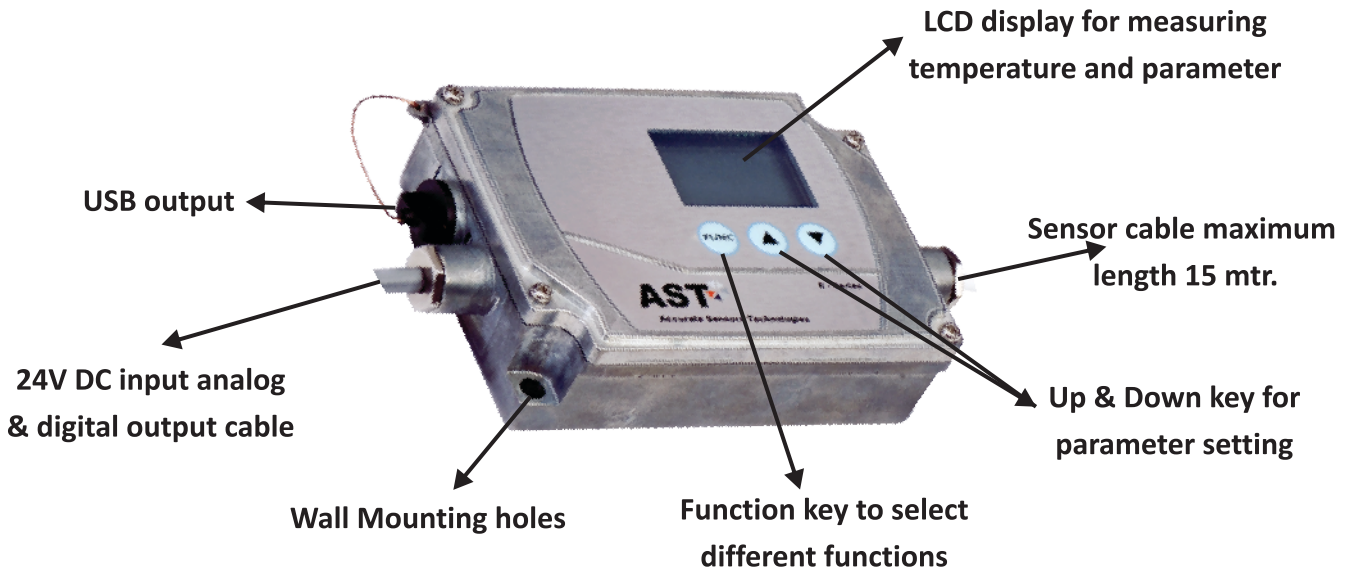

User can power up the unit either by USB input or by using 7 core connection cable at 24V DC input. After power up sensor starts an initializing routine for some seconds. After this the object temperature is shown in the display. User has to remove the screw (mark USB in figure) to connect the unit with PC via USB cable.

#### 4.1 Operation

The programming keys FUNC, UP and DOWN enable the user to set the device on-site. Normally, LCD shows temperature or error. To view different parameter FUNC key is pressed repeatedly. To change values of parameters UP & DOWN keys are used. After changing values in any parameter by UP & DOWN key finally FUNC key should be pressed to save that value in device. If FUNC key is not pressed after changing parameter value than device will automatically take the old value & device will start showing temperature. If any key is not pressed for more than 5 sec. than device will automatically shows the temperature.

For targeting LED light is provided in device. Press UP + DOWN key simultaneously to change the present condition of LED (ON / OFF).

#### 4.2 Adjustable parameters

- Emissivity** : It is the relationship between the emissions of a real object and the emission of a black body radiation source at the same temperature. For a correct measurement it is necessary to adjust emissivity. Emissivity depends on the surface condition of the material, the spectral range of the pyrometer and the measuring temperature. Different material has different emissivity ranging from 0.1 to 1.0. user can change emissivity by given keypad on the instrument.
- Set point** : Instrument is equipped with a relay contact controlled by the measuring signal. The turn on temperature of relay is adjusted within the measuring range. The relay contact is "OPEN" below the adjusted value, it is "CLOSE" above it.
- Hysteresis (Hyst.)** : The relay contact close when temperature exceeds the set point. It opens only if the temperature falls below a value which consists of set point and the adjusted hysteresis. It can be adjusted from 2° to 20°C.

**Example :** if set point value is 500°C and Hysteresis set to 10. Then relay operation as below mentioned:

1. Relay contact OPEN below 510°C temperature.
2. Relay contact CLOSE above 510°C temperature.
3. Once relay contact CLOSED than relay contact is OPEN's when temperature falls below 490°C.

- Ana. Sub range LO** : Analog sub-range is adjustable within the basic range, user can set lower analog sub-range here.
- Ana. sub range HI** : User can set the analog sub-range higher value here. Minimum span between lower & higher value is 51°C
- Analog output** : User can select the output from 4...20mA or 0...20mA or 0...10V
- Temp. Unit** : User can select °C or °F unit.
- Sensor address** : For communicating with pyrometer via software users have to give a address. The address may be 1 to 255.
- Response time** : The response time can be set from 10msec to 10sec.
- Picker** : User can calculate a maximum “peak” temperature value from specified number stored real temperature in the sensor memory. User can either on or off the picker.
- Head temp.** : It shows the temperature of head.
- Internal temp.** : It shows the internal temperature of pyrometer.

#### 4.3 Connection diagram

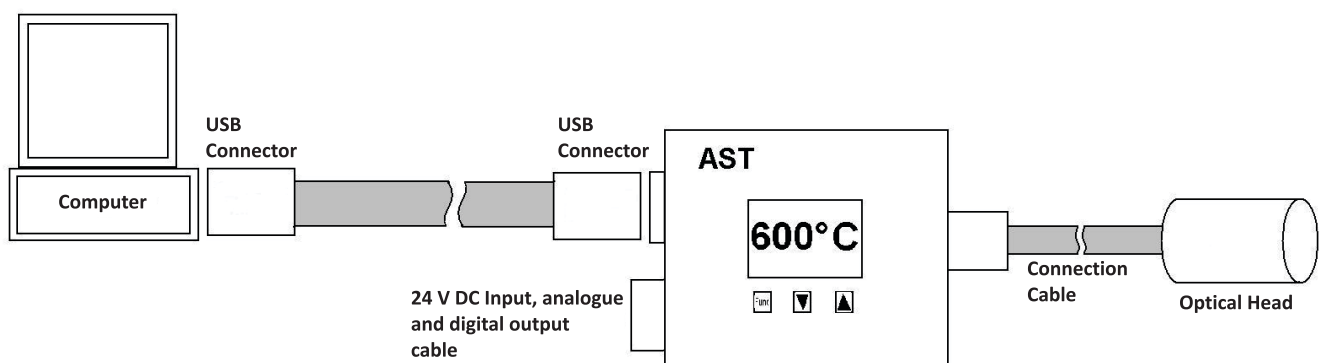

#### Connection through USB cable

**Note :-** When the Pyrometer is only powered through USB, the Analog output, LED/Laser and Relay Function not available.

### 4.4 Pin assignment

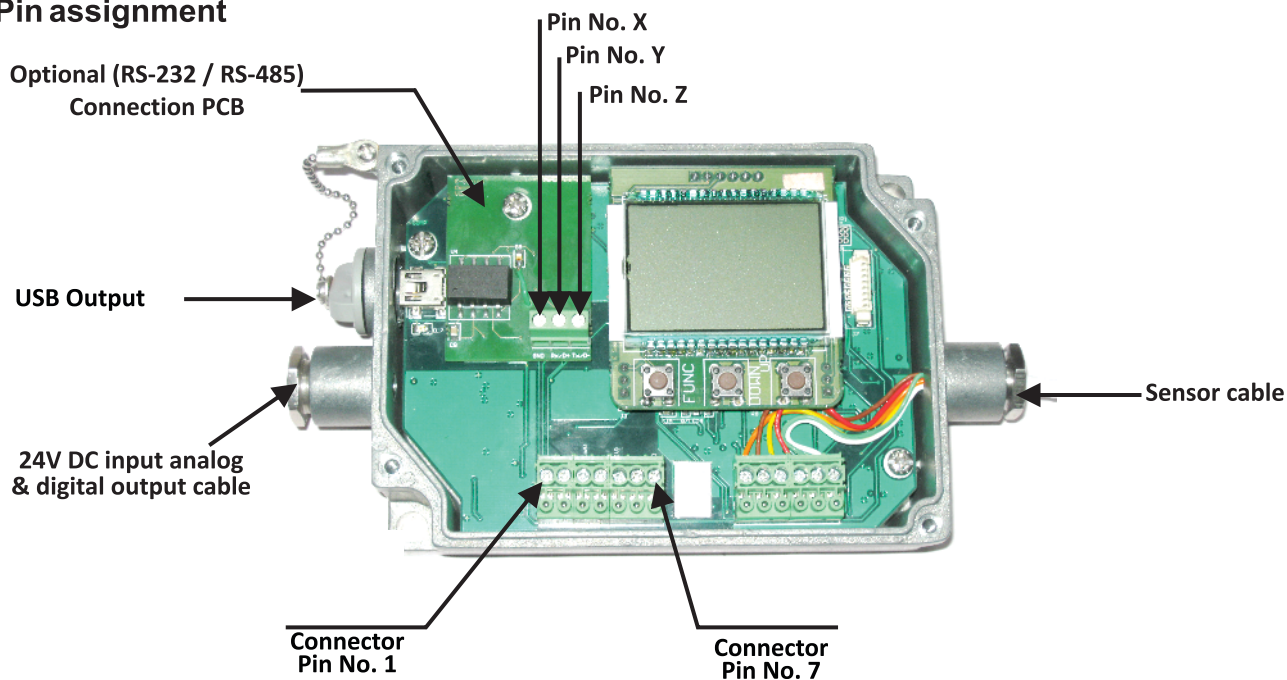

#### Connector pin assignment:

Pin number	Indication	Descriptions
7	RL1-NO	Relay terminal 1
6	RL1-C	Relay terminal 1
5	Out V (+)	Analog output voltage
4	Out V/mA (-)	Analog output voltage/current (-)
3	Out mA(+)	Analog output current (+)
2	0 V	DC supply GND
1	+24 V	DC supply

#### Optional (RS-232 / RS-485) PCB Connection

Pin number	Indication	Descriptions
X	GND	RS-232 / RS-485 GND
Y	Rx/D+	Rx(RS-232) / D+(RS-485)
Z	Tx/D-	Tx(RS-232) / D-(RS-485)

**Note:** 1. For Analog output, DC supply (+24V DC) is must given to pyrometer first.

# Chapter - 5

## Optics

The pyrometer measure temperature by receiving heat radiation, from the object whose temperature has to be measured. This heat radiation is passes through the lens to the sensor and is then converted to an electrical signal. The farther the measured object is from the pyrometer, the larger the area that will be measured by the pyrometer. Depending on customer need, the pyrometer is designed for fixed optics with different focusing distance. User has to select the working distance while ordering.

Contamination on lens will cause inaccurate temperature reading therefore air purge unit is used for sensor head. Cleaning with dry cloth is sufficient for lens cleaning.

### 5.1 Sensor head details

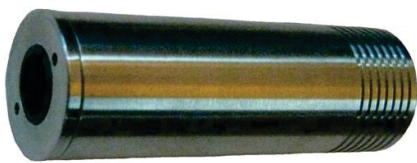

**Material :** Stainless steel  
**Dia :** 25 mm  
**Length :** 72mm

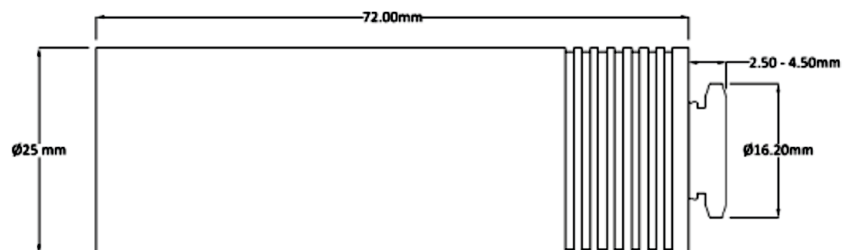

### 5.2 Optical specification

Standard spot sizes (in mm) according to working distance shown in below table.

Working distance (mm)	AST E250-PL			AST E450-PL
	250°-1000°C	300°-1300°C	350°-1800°C	600°-1900°C
90	4.5	2.25	1.2	1.2
300	15	7.5	3.8	3.8
600	30	15	7.5	7.5
<b>Aperture</b>	5	5	5	5

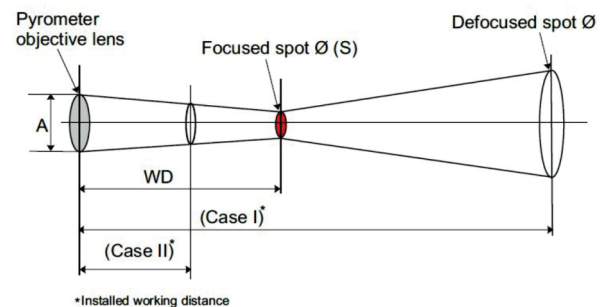

\* Manufactured working distance (WD) mentioned on the pyrometer.

If the pyrometer is not installed at manufactured working distance (WD) then spot size at actual installed distance should be calculated. For example, if factory made working distance is 300mm and pyrometer AST E 250-PL (350°C-1800°C), then spot size is 3.8mm (as given in table). If user installed this pyrometer at 600mm then spot size is not 7.5mm (as given in table), user should have to calculate as given below method.

**Case-I: If installed working distance is greater than manufactured working distance**

$$\text{Installed Spot size} = \frac{\text{Installed working distance (Case I)}}{\text{WD}} \times (S + A) - A$$

**Case-II: If installed working distance is smaller than manufactured working distance**

$$\text{Installed Spot size} = \frac{\text{Installed working distance (Case II)}}{\text{WD}} \times (S - A) + A$$

# Chapter - 6

## Accessories

### 6.1 Electrical Accessories

#### 6.1.1 Power supply unit

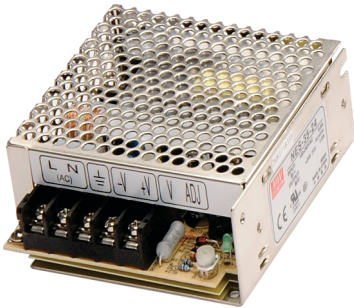

**Power supply unit  
(Reference no: 9000-02)**

AST E 250/450 PL is powered by 24V DC (well stabilized ripple max 50mV).The input power supply is 110/230v AC check the polarity before connecting the device.

#### 6.1.2 Temperature display instrument



**Temperature indicator  
(Reference no: 9000-01)**

To display the measured temperature 7 segment digital indicator is used. Device has following specifications:

Power supply I/P	:	85 to 265 V, AC/DC
Analog I/P	:	4....20 mA
Retransmission	:	4....20 mA
Power supply O/P	:	24V, DC
Display	:	4 Digits
Alarm	:	2



### 6.1.3 Display & parameterizer



**Display & Parameterizer  
P-120  
(Reference no:9001-01)**

AST P-120 is a high precision LED indicator for non contact temperature measurement. With indication of measured temperature user can easily parameterize a connected AST digital pyrometer without any PC.

Device has following specification:

Power supply	:	100 – 240V, AC or 24V, DC
DC analog O/P	:	0-20 mA or 4-20 mA
Digital interface	:	RS-232 or RS-485
Pilot light	:	Pilot light On/Off with keys

### 6.1.4 Converter RS-485 ↔ RS-232 :



**Converter RS-232 ↔ RS-485  
(Reference no: 9000-03)**

The pyrometer can communicate with PC using RS-485 or RS-232. RS-232 is used only for short distances.

RS-485 is well suited for long distance transmission. Standard on PC is RS-232, so a converter is used which converts RS-485 to RS-232.

## 6.2 Mechanical Accessories

### 6.2.1 Adjustable mounting support for sensor head

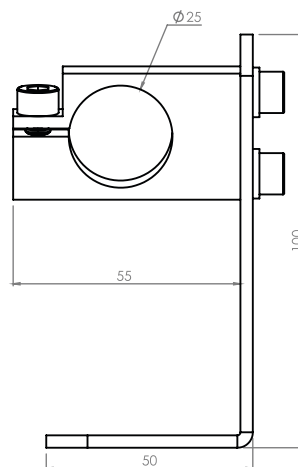

**Adjustable mounting support**  
(Reference no: 8200-03)

### 6.2.2 Air purge unit for sensor head

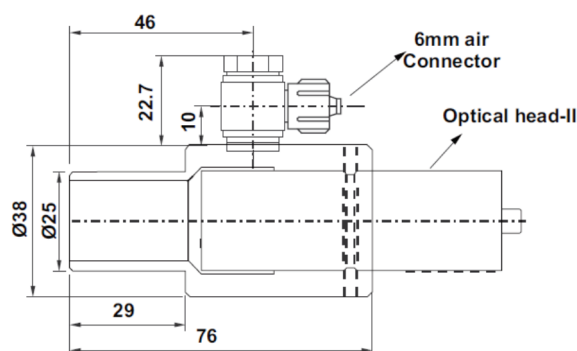

**Air purge unit for sensor head**  
(Reference no: 8200-03)

### 6.2.3 Water cooling jacket & Air purge unit for optical head II

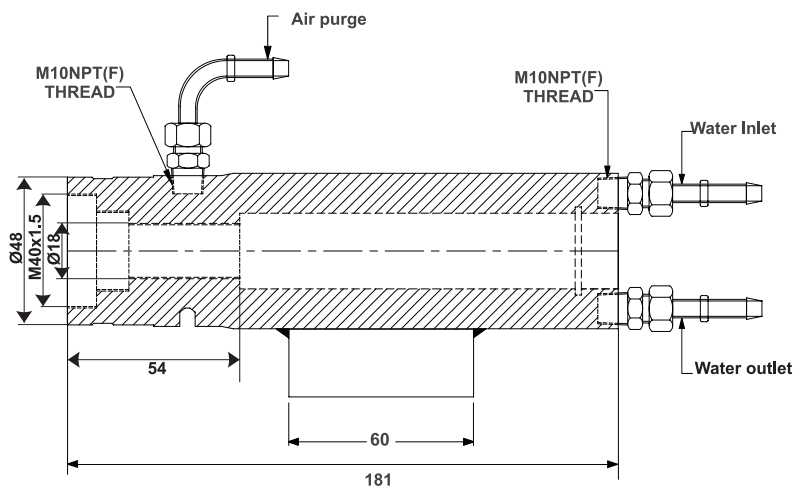

Water pressure	: < 10 bar
Air pressure	: < 0.5 bar
Dry and clean air (oil and dust free)	
Air consumption	: 2...3 m <sup>3</sup> /h
Ambient temperature	: < 180°C
Metal	: Stainless steel
Weight	: 0.45 Kg

**Water cooling jacket & Air purge unit for optical head II**  
(Reference no: 8000-01)



# Chapter - 7

## Software Installation

The provided AST software “InfraSoft” offers digital PC interface RS-232 & RS-485. Using this software we can set all the parameters like response time, analog scale, emissivity, clear time, communication mode. This software provide all necessary information about pyrometer.

### 4.1 Installation

Install the pyrometer software using the installation guide file on CD ROM & restart your PC as per guidelines provided for installation. After installation of the software; Double click the application. It will open the screen of software.

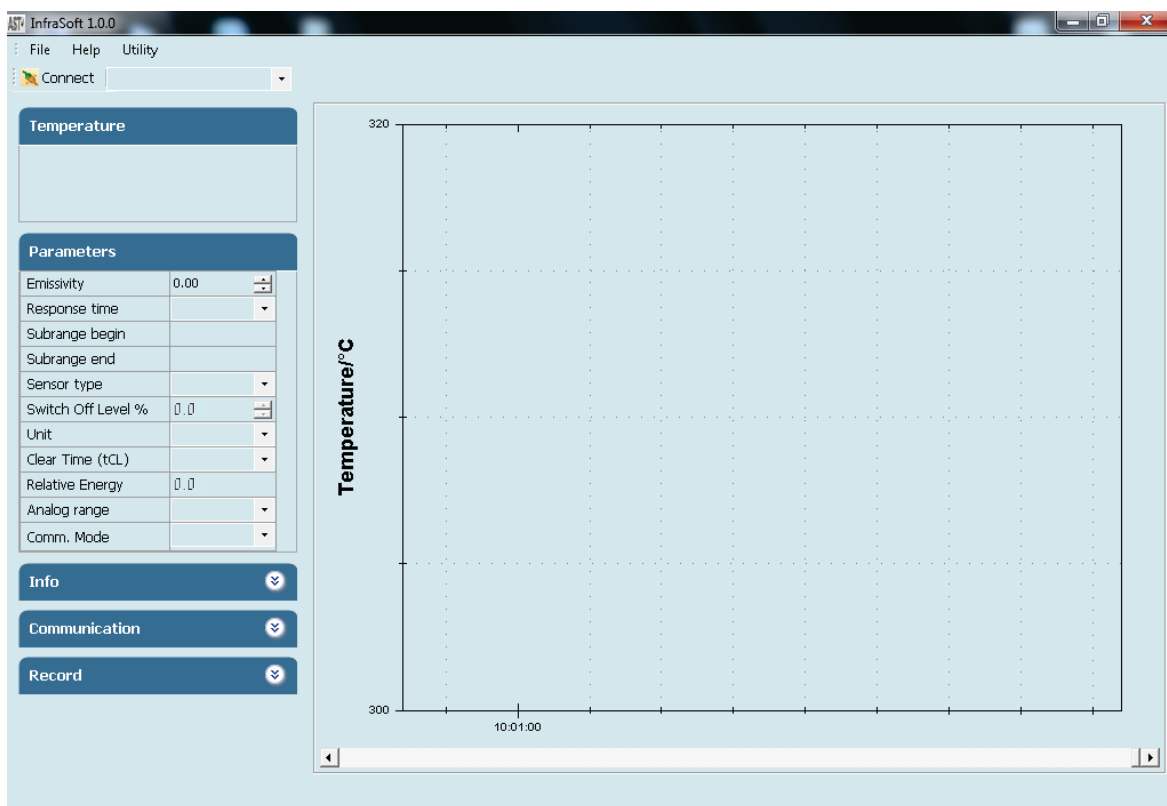

### 4.2 Parameters in main screen

#### 4.2.1 Communication

Communication between the AST pyrometer and the software is implemented via a cable connected between the pyrometer and the PC serial port. This enables the acquisition and recording of data, as well as the transfer of commands from the software application to the AST pyrometer. Communication can be done by clicking on “Communication panel” and select correct COM Port address where pyrometer is connected. Also user has to select address of the pyrometer(Example: Default 01/ printed on the pyrometer sticker). Then click on CONNECT Button.

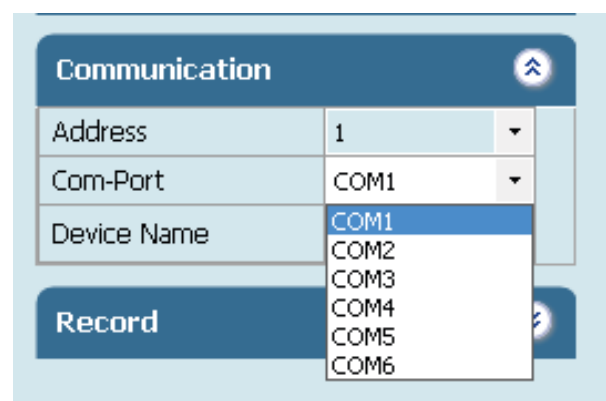

For communication of multiple pyrometers, select different com port and address.

#### 4.2.2 Temperature

It shows the temperature measured by the pyrometer

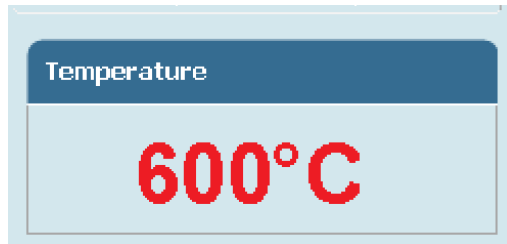

#### 4.2.3 Parameter Setting

All user selectable device parameters can be set by using the software in the Panel "Parameter"

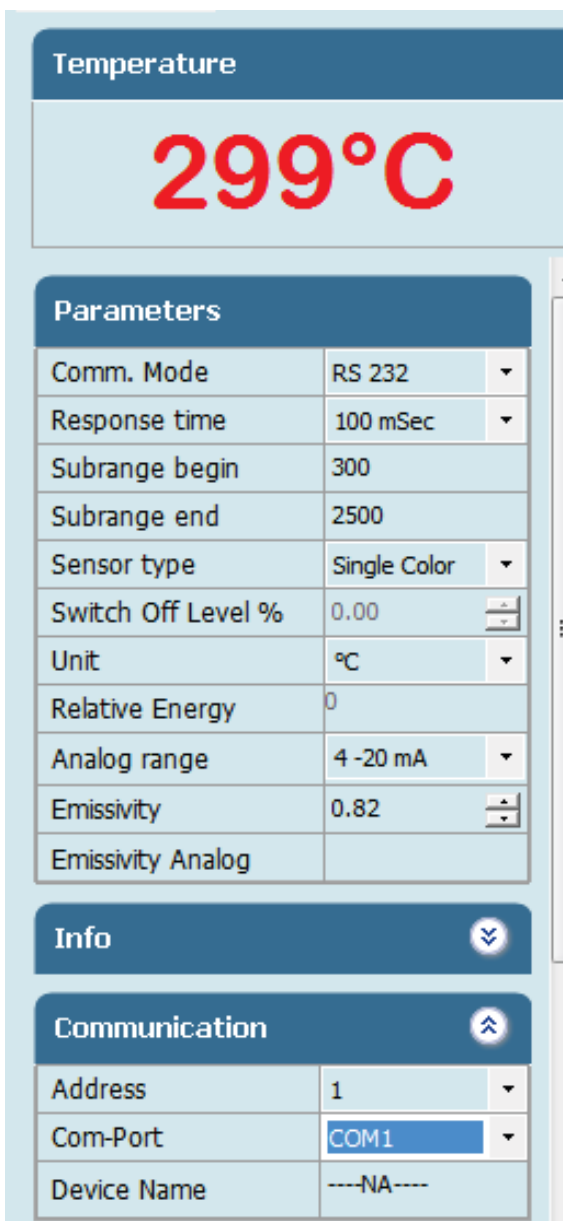

**(A)Emissivity settings** The emissivity can be set by clicking on "Parameters" and select or type in the desired emissivity directly in the description field. The emissivity value will be transferred to pyrometer by hitting the "TAB" button.

**(B)Response time** The desired response time can be chosen in the panel Parameter by clicking the appropriate list box (as per the values available in the drop box of response time). This parameter is use to set the analog response time of pyrometer.

**(C)Sub Range** User can change the sub range of pyrometer in the panel Parameter. Sub range must be within the basic range of pyrometer, the minimum span between higher & lower range is 51. Analog output will be automatically set according to the sub-range by hitting "TAB" button.

**(D)Sensor Type** It shows pyrometer sensor type. User can change sensor type from two color to single color and vice versa (only applicable with two color pyrometer).

**(E)Switch off level% ( for two color pyrometer)** The switch of level is the function that is used to avoid measurement errors caused by signals, which are too low. Although factory default is set to 15 %, the switch off limit can be adjusted between 2 and 50%.

**(F)Unit** User can change the measuring unit of temperature from "Centigrade" to "Fahrenheit" and vice versa.

**(G) Peak Picker Setting** Three Pickers are available in Pickers setting menu (Auto, tCL, Smart) & user can switch on any as per requirement, one at a time.

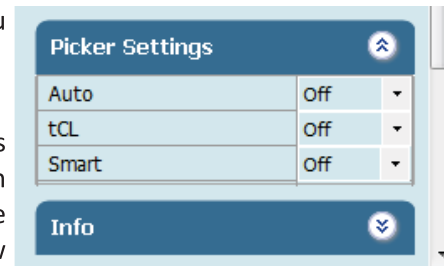

**(G1) Auto** “Auto” mode is used for discontinuous measuring task, such as object being transported on a conveyer belt in such a case the maximum value for each object has to be indicated. when the object passes the measuring beam of the pyrometer, the maximum value is stored until a new hot object appears in the measuring beam. The temperature which has to be recognized as “hot” is defined by the low limit of the adjusted sub range. The stored maximum value will be deleted when the temperature of the new hot object exceeds the low limit “from” of the sub range by at least 1°C. If a lower limit is not entered, the maximum value storage will be deleted whenever the low level of the full measuring has been exceeded.

**(G2) Clear time (tCL)** If the peak picker is switched on, the highest last temperature value will always be displayed and stored. As such, it may be beneficial to periodically clear and reset the stored values in order to obtain new temperature readings.

**Example :** If we set the tCL a s “6 sec” the highest last temperature value will be display for 6.0 sec to 12 sec then it capture next pick.

**The following setting are possible :**

**OFF :** At clear time “OFF” the maximum value storage is switched off and only momentary values are measured.

**tCL (10msec...25sec) :** Clear Time tCL can be set between 10msec and 25sec. When set, estimates the maximum values and holds it in two buffer memory. After the entered time, the storage will be deleted.

Clear Time feature is particularly useful when object temperature is not uniform across its dimension or the pyrometer is not constantly viewing an object to be measured. The peak picker works on two buffer memory to find maximum value over a defined interval. With the first memory, the highest measured value is held and is deleted alternately in the time interval set (clear time). The other memory retains the maximum value throughout the next time interval. The disadvantages of fluctuations in the display with the clock frequency are thereby eliminated.

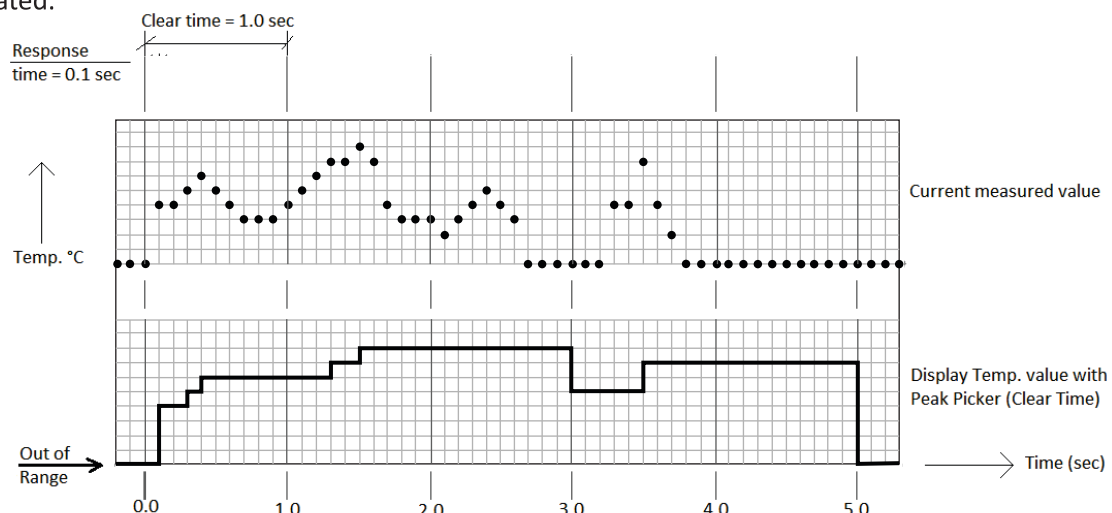

**Note:**

The maximum value storage coincides with adjustments made to response time. Therefore:

- (i) Clear time <= the adjusted response time is useless
- (ii) Clear times must be at least 5 times longer than the response time.
- (iii) Only maxima with full maximum value can be recorded, which appear at least 5 times longer than response time.

**(G3) Smart** If the smart picker is switched on, the highest last temperature value will always be displayed and stored. This feature is particularly useful when object temperature is not uniform across its dimension or the pyrometer is not constantly viewing an object to be measured.

**Smart Picker Functions**

Smart picker can be turn ON & OFF by using the software. When Peak picker is ON, the peak picker menu is enabled for setting of the parameters like decay rate function, reset below temperature and peak picker delay.

Temperature

231°C

Sensor type	Single Color
Switch Off Level %	0.00
Unit	°C
Relative Energy	0
Analog range	4 -20 mA
Emissivity	0.13

Picker Settings

Auto	Off
tCL	Off
Smart	On
Decay Rate (Temp./Sec.)	5
Delay Time (Sec.)	10
Reset Below Temp.	200

Info

Communication

**(I)Decay rate** The Decay rate range is 0.00 to 166.66°C/sec. or 0.00 to 300°F/sec. depending upon °F/°C unit’s selection. The slowest Decay rate is 0 degrees per sec. This feature helps to eliminate erratic measurements and allows the peaked value to decay down to lower process temperature values as they occur. Decay rate is set to retain peak measured temperature value and ignore momentary decreases in measured temperature.

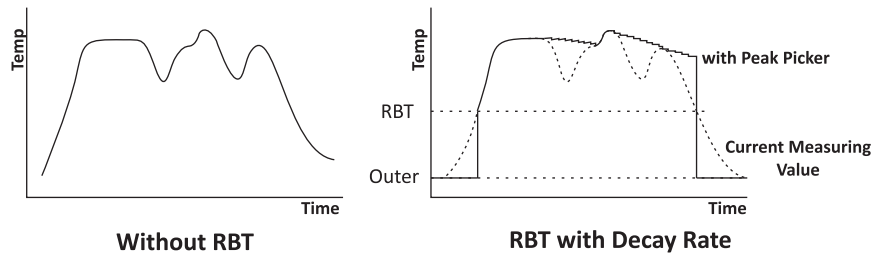

**(II)Delay Time** This function set the delay time in sec. before peak picker function starts. The delay time is selectable in the range 0.02 to 10.00 sec. Zero (0) turns delay time OFF. This function is used to delay the start of peaking action for upto 10 sec. following the detection of leading edge of a new target.

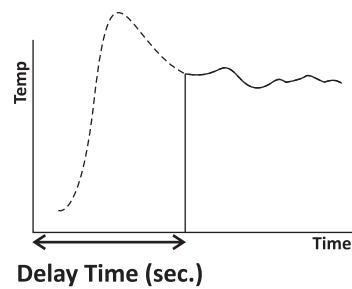

**(III) Reset Below Temperature(RBT)** The user can set RBT within the limit of pyrometer sub range. This function sets the temperature above which peak picker action starts. When the target temperature matches or is below the selected value, the sensor indicates temperature without picking action.

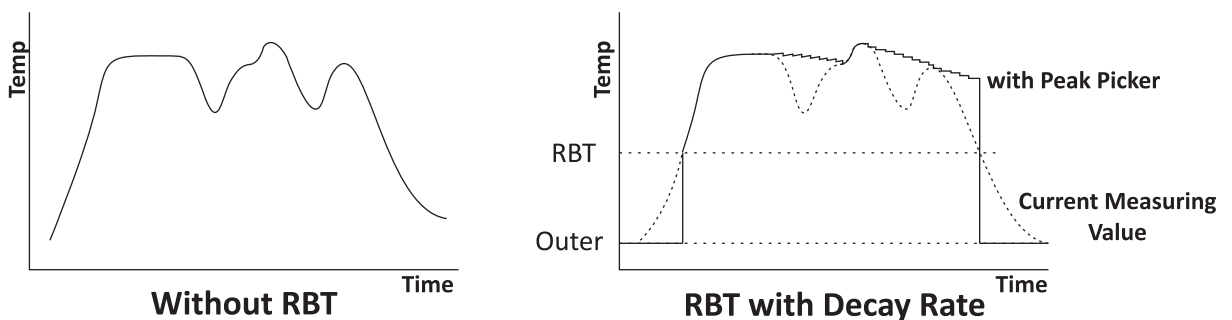



File will be stored in **.xls** format named as “export”. This “export.xls” file will be saved where the software is installed.

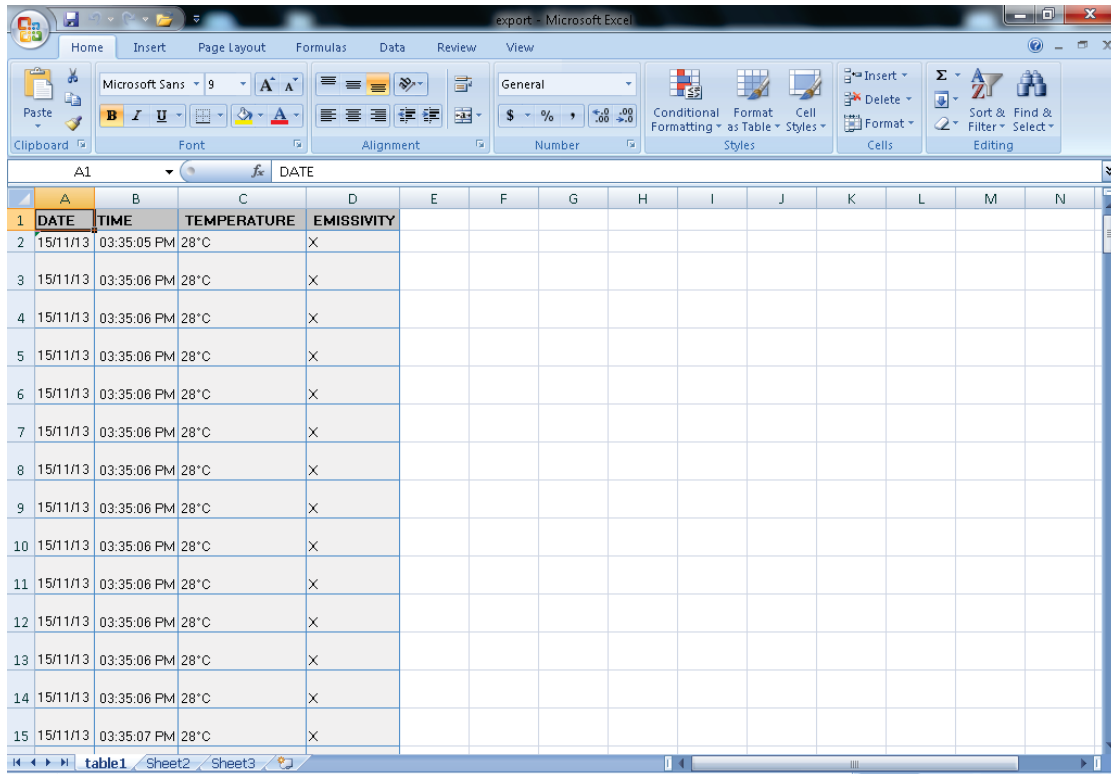

To see previous record open the file by clicking on menu **File** → **open**.  
Screen containing historical trend & historical data will appear.

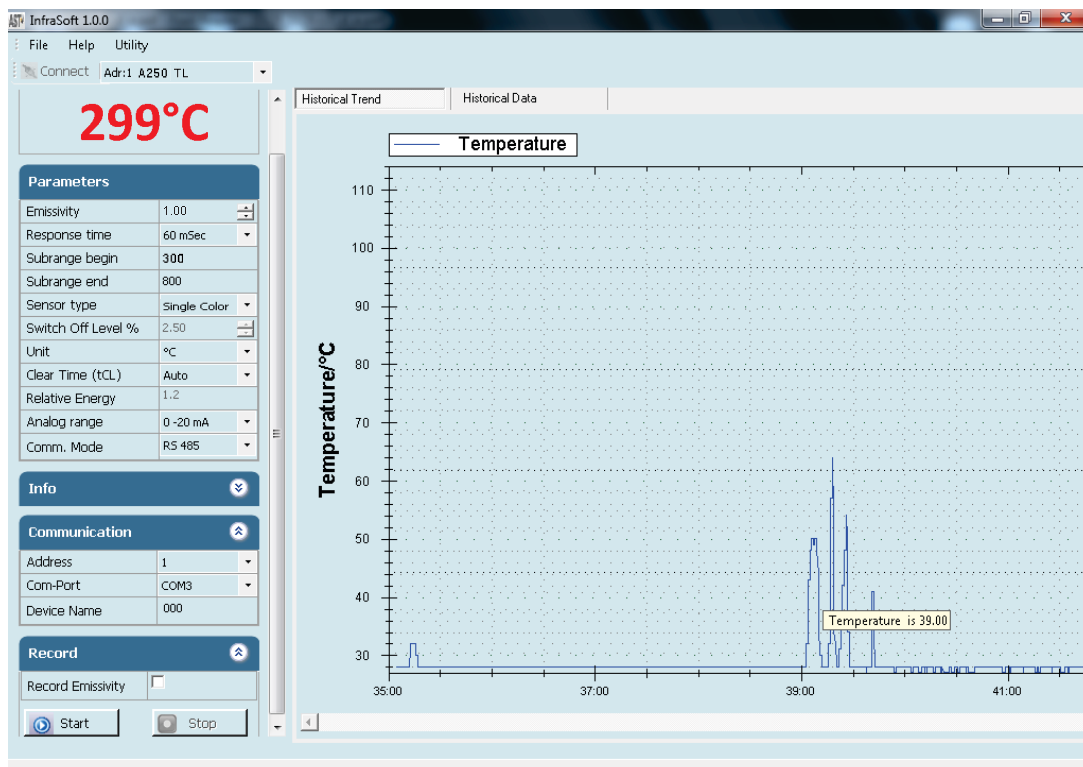

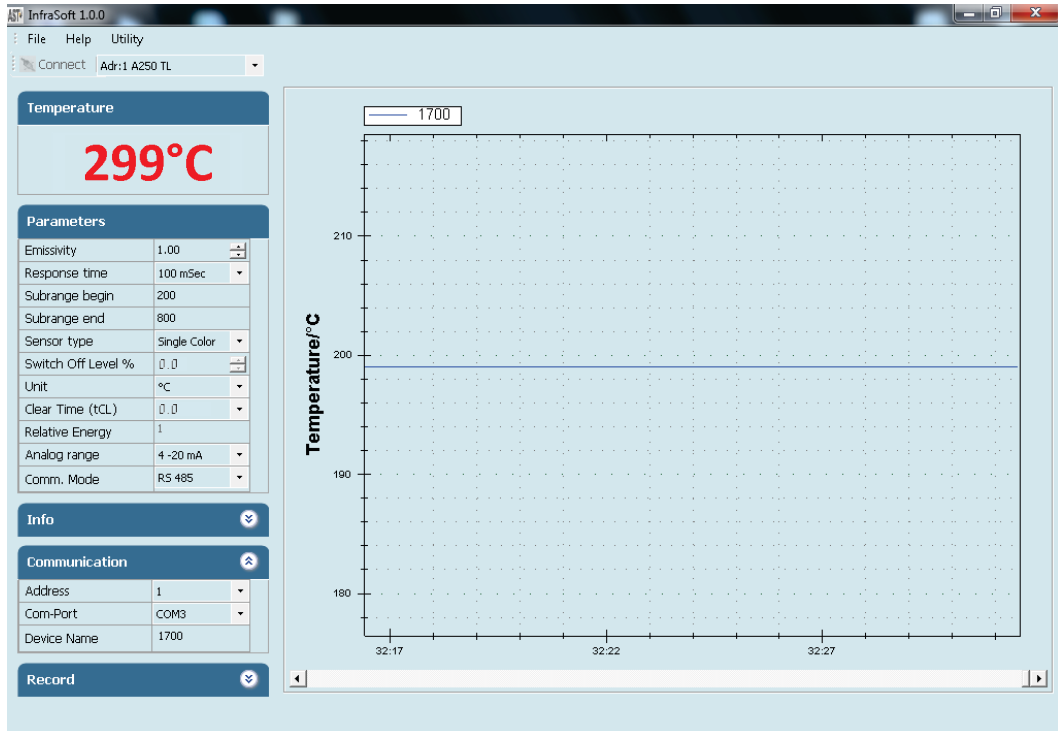

Temperature graph of connected pyrometer is displayed on right side of the screen. This shows the measured temperature corresponding to the time.

**Note:**

After connecting the pyrometer right click on the graph screen and choose "Set to default" option from pop-up menu.

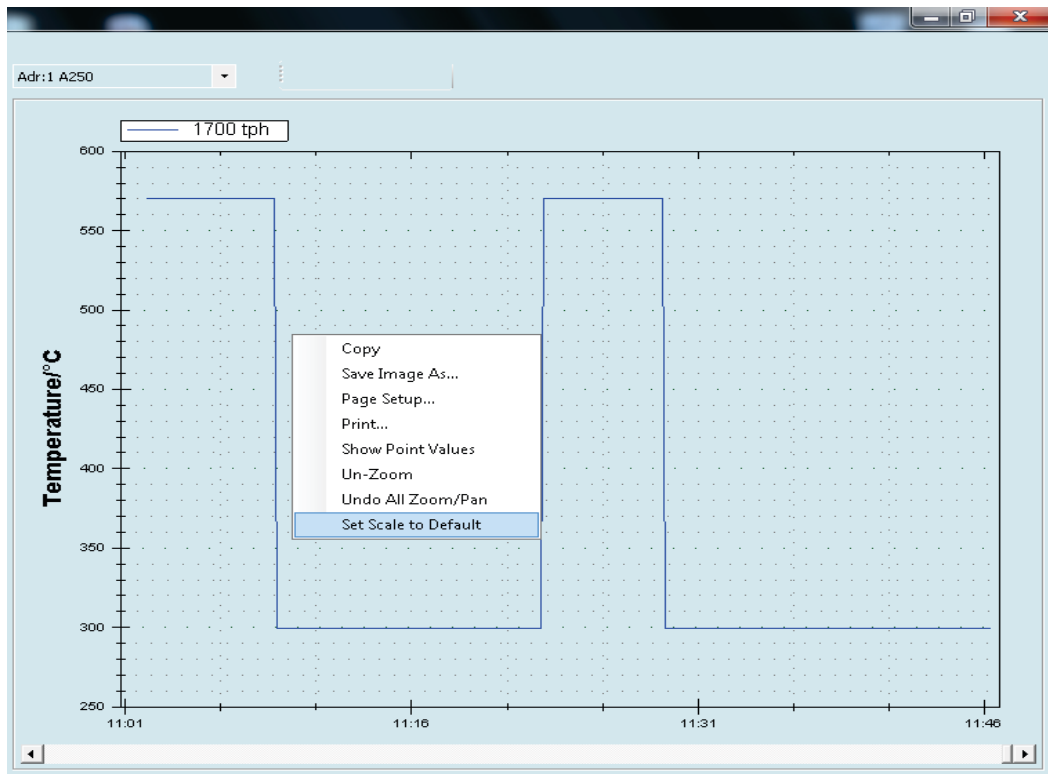

# Chapter - 8

## Calculate Spot Size

To calculate Spot Size click on **Utility** → **Calculate Spot Size**

This option is used to calculate the spot size at installed working distance of the Pyrometer. When you click on calculate spot size the new window will open.

- WD = Manufactured working distance in (mm).**
- A = It shows the value of lens opening (Aperture in mm)**
- S = Manufactured spot size of the pyrometer (mm)**

User has to enter the value of WD, A, S, of the installed pyrometer (These values are given in section – 2.3). Now, putting the value of “Installed working distance” it will show the value of “Installed spot size”.



# Chapter - 9

## Serial communication protocol-MT500

This protocol is developed to use in the half duplex addressable communication mode. Master device should periodically issue requests to each Slave device. The request contains an address of polling “Slave” device. Slave device reply only on the requests issued by Master. Each Slave has its own address to recognize the issued request. AST sensors always operate as Slave devices. Using RS485 serial communication option allows connecting more than one sensor to Master device. AST sensors always perform delay of 5 ms before sending an answer on Master request to meet RS485 hardware requirement.

MT500\_AST protocol uses only RD (Batch Read) and WD (Batch Write) commands. Sending other MT500 protocol commands causes sensor to consider it as error condition and answer with unknown command reply. Symbols enclosed within apostrophes (‘symbol’) means ASCII representation of the symbols. String enclosed with quotation mark (“string”) means ASCII representation of the string (ended by ‘\0’). Data format is: 8 data bit, 1 stop bit, No parity, baud-rate 19200.

Description	Address	Items	Parameters
Emissivity	'0400'	'01'	Object emissivity multiplied by 1000. Refer user manual for adjustable range.
Emissivity slope	'0401'	'01'	Emissivity slope parameter multiplied by 1000. Refer user manual for adjustable range.
Response time (τ)	'0105'	'01'	Parameter specifies analog and serial output response time. See Table 1.
Upper basic range	'0100'	'01'	Upper measurement range limit in °K (read only)
Lower basic range	'0101'	'01'	Lower measurement range limit in °K (read only)
Analog output type	'0F01'	'01'	'0000': 4 to 20 mA (Default); '0001': 0 to 20 mA, '0002': 0 to 10 Volt; '0003': K type TC; '0004': J type TC
Upper sub range	'0102'	'01'	Upper analog scale value in °K
Lower sub range	'0103'	'01'	Lower analog scale value in °K
Station number	'0200'	'01'	Adjustable between '0001' to '0255'
Temperature unit	'0201'	'01'	Flag is used to instruct PC SW to show temperature '0000': Centigrade (Default); '0001': Fahrenheit
Switch off level	'0107'	'01'	Parameter multiplied by 10. Adjusted between 0 and 100%, Default set to 15%.
Sensor mode	'0204'	'01'	'0000' = Single color; '0001' = Two color This parameter is useless for single color sensors.
Internal temperature	'0006'	'01'	Temperature inside device case in °C (read only)
Head temperature	'0007'	'01'	Temperature inside optical head m°C(only for E –series pyrometers) (read only)
Clear time(tCL)	'0303'	'01'	Adjustable between 0 to 12, Default 0, 0=OFF, 1=Auto. 2-12 = 10msec to 25sec [refer to page-13(clear time)]
Laser control	'0F00'	'01'	'0000': LASER OFF; '0001': LASER ON (Default)
Communication type selection	'0F03'	'01'	'0000':RS-485;; '0001': RS-232 (Default)
Set point	'1700'	'01'	Set point for relay actuation (only for E –series pyrometers)
Hysteresis	'1800'	'01'	Hysteresis value relay actuation
LCD back light control	'1801'	'01'	'0000': BL OFF; '0001': BL ON(Default) (Only for E-series pyrometers)
Device name	'1D00'	'01'	10 Bytes “Hot end ”, if less then 10 bytes pad with space at end.
Working distance (mm)	'1D01'	'01'	10 Bytes “1000 ”, if less then 10 bytes pad with space at end.
Spot size-aperture (mm)	'1D02'	'01'	10 Bytes “1000-6000” if less then 10 bytes pad with space at end. '/' sign between spot size and aperture is compulsory
Relative energy (read only)	'0002'	'01'	Relative energy multiply by 1000 for 2 color pyrometers only

Device model number (read only)	'0E00'	'01'	10 bytes "AST450C ", if less than 10 byte pad with space at end
Firmware version	'1300'	'01'	Firmware version number of device (read only)
Sensor serial number (read only)	'1400'	'01'	6 bytes in hex, if less than 6 bytes pad with '0' at start. Only numbers allowed.
Device type (read only)	'1301'	'01'	'0001': Single color; '0002' : Two color '0003': Thermopile; '0004' : Reserved
Real temperature and status code (read only)	'0000'	'02'	Calculated object temperature in °K and status of sensor (As shown in Appendix A). First process status code then real temperature.

### Batch Read (RD)command:

Byte 1	Bytes 2,3	Bytes 4, 5	Bytes 6-9	Bytes 10, 11	Byte 12	Bytes 13, 14
1 Byte	2 Bytes	2 Bytes	4 Bytes	2 Bytes	1 Byte	2 Bytes
STX	Station ID	RD	Address	Items	ETX	Checksum

Byte 1: Always STX (0x02)

Bytes 2, 3: The Station Number of the device to read from (2 Hex digits)

Bytes 4, 5: The command to execute (RD)

Bytes 6-9: This is the starting address to read from. Must be 4 bytes long

Bytes 10, 11: This is the number of addresses to read. Must be 2 bytes long

Byte 12: Always ETX (0x03)

Bytes 13, 14: The checksum is the lowest 8 bits of the sum of bytes 2 through 12

**Example :** Read two parameters starting from address 0000, from the station number 10 (0AH). This will read addresses 0000 and 0001.

Byte 1	Bytes 2, 3	Bytes 4, 5	Bytes 6-9	Bytes 10, 11	Byte 12	Byte 13, 14
STX	0A	RD	0000	02	ETX	2E
0x02	0x30, 0x41	0x52, 0x44	0x30,0x30,0x30,0x30	0x30, 0x32	0x03	0x32, 0x43,

Checksum is calculated as the lowest 8 bits of the sum of the Hex codes for bytes 2 to 12.

### Reply:

The reply length is  $L = (N * 4) + 8$ , Where N = the number of requested Items.

If the command is successful, the reply length will be at least 12 bytes. It consists of the STX, followed by four bytes for each requested item, then the ETX and Checksum.

Byte 1	Bytes 2, 3	Bytes 4, 5	Bytes 6-9	Bytes 10-13	Byte L-2	Byte L-1, L
STX	Station	RD	Data 1	Data N	ETX	Checksum

Reply to above command if address '0000' contains value 1497 and address '0001' contains value 0000.

Byte 1	Bytes 2, 3	Bytes 4, 5	Bytes 6-9	Bytes 10-13	Byte 14-15
STX	0A	RD	059D	0000	9C
0x02	0x30, 0x41	0x52, 0x44	0x30,0x35,0x39,0x44	0x30, 0x30, 0x30, 0x30	0x39, 0x43

in the event of an error, the reply is

Byte 1	Byte 2, 3	Byte 4, 5	Byte 6
NAK	0A	'R', 'D'	01
0x15	0x30, 0x41	0x52, 0x44	0x30, 0x31

### Batch Write (WD) command

Byte 1	Bytes 2, 3	Bytes 4, 5	Bytes 6-9	Bytes 10, 11	Bytes 12-15	Bytes (L-6) - (L-3)	Byte L-2	Byte L-1, L
STX	Station ID	WD	Address	No. of Items	Data 1	Data N	ETX	Checksum

Byte 1	Bytes 2, 3	Bytes 4, 5	Bytes 6-9	Bytes 10, 11	Bytes 12-15	Byte 16	Byte 17,18
STX	0A	WD	0400	01	03E8	ETX	74
0x02	0x30, 0x41	0x57, 0x44	0x30, 0x34, 0x30, 0x30	0x30, 0x31, 0x30, 0x30	0x30, 0x33, 0x45, 0x38	0x03	0x37, 0x34

### Reply :

If the command is successful, the reply is

Byte 1	Byte 2, 3	Byte 4, 5
ACK	0A	'W', 'D'
0x06	0x30, 0x41	0x57, 0x44

In the event of an error, the reply is

Byte 1	Byte 2, 3	Byte 4, 5	Byte 6
NAK	0A	'W', 'D'	01
0x15	0x30, 0x41	0x57, 0x44	0x30, 0x31

**Error Codes:**

<b>Error Code</b>	<b>Description</b>	<b>Comments</b>
'1'	Invalid check sum	See how to calculate a check sum
'2'	Unknown command	Protocol uses only RD (Batch Read) and WD (Batch Write) commands
'3'	Data length error	Number of items in WD (Batch Write) command doesn't match number of data bytes
'4'	ETX not found	ETX (0x03) not present in command
'5'	Illegal Address	number of items in a request is set to 0; memory segment number in a request is out of 0-25; Wrong command value, No data at requested address;
'6'	More items requested	More than 99 items were requested in command
'7'	Unsuccessful write	It informs Master that it should repeat WD command

**Table 1:**

<b>Tau (<math>\tau</math>)</b>	<b>Analog Response Time, ms</b>	<b>Serial Response Time, ms</b>
1	2	20
3	6	50
5	10	100
10	20	200
30	60	300
50	100	500
100	200	1000
300	600	2000
500	1000	3000
1000	2000	4000
3000	6000	5000
5000	10000	10000

**Appendix A:**

DATA	Comments
Status code	'0000' : No error '0001' : Signal is lower than sensor sensitivity '0002' : Out of range due to T brightness minimum '0003' : Too low energy '0004' : Signal is higher than sensor sensitivity '0006' : Sharp brightness jump '0007' : Non stable object measurement '0011' : Internal temperature warning '0013' : Thermopile ambient temperature too low '0014' : Thermopile ambient temperature too high '0015' : Pyrometer in testing mode '0016' : Pilot light ON '0017' : Measurement below lower basic range '0018' : Measurement exceeds upper basic range '0019' : Pyrometer in warm up period

**Broadcast Message:**

WD (Batch Write) command with Station ID of 0 is considered as broadcast message. Sensors process this command regardless of their Station Number and do not issue replies.

It is useful when master issues a request to change the same parameters of more than one Slave devices.

For more information write us at, [technical@accuratesensors.com](mailto:technical@accuratesensors.com)

# Information

## Maintenance

The pyrometer has no internal parts, which have to be cleaned. The lens can be cleaned with compressed air, which is dry and free of oil. If the protection glass requires more thorough cleaning, use a soft, dry cloth such as that used to clean camera lenses.

## Packing instructions

To transport or store the instrument, please use the original box or a box padded with sufficient shock absorbing material. For storage in humid areas or shipment overseas, the device should be placed in welded foil (ideally along with silicone gel) to protect it from humidity.

## Warranty

AST E250/E450 PL instruments have a warranty of two years from the invoice date. This warranty covers manufacturing defects. User-induced faults are not covered under this warranty.

## Software warranty

The windows compatible software was thoroughly tested on a wide range of windows operating systems. Nevertheless, there is always a possibility that windows or PC configuration or some other unforeseen condition exists that would cause the software not to run smoothly. The manufacturer assumes no responsibility or liability and will not guarantee the performance of the software. Liability regarding any direct or indirect damage caused by this software is excluded.

## Limit of liability

AST not liable for any damages that arise from the use of any examples or processes mentioned in this manual.

*Specifications are subject to change without notice*

Copyright: © 2009, AST. All rights reserved.

This document may contain proprietary information and shall be respected as a proprietary document to AST with permission for review and usage given only to the rightful owner of the equipment with which this document is associated.

AST reserves the right to make changes, without further notice, to any products herein to improve reliability, function, or design. AST does not assume any liability arising out of the application or use of any product described herein, neither does it convey any license under its patent rights nor the rights of others.

Copyright: © 2009

# ABOUT US

## AST - Accurate Sensors Technologies

Accurate Sensors Technologies along with 3T - True Temperature Technologies established in 1994 focusing on the development and commercialization of non-contact temperature measurement technologies.

Based on these technologies, AST/3T has brought to the market a line of pyrometers for the remote measurement of target temperatures using no physical contact. AST/3T pyrometers use a totally new approach for remote temperature measurement achieving high accuracy.

The following products are available from AST/3T

- ❖ Single color pyrometer
- ❖ Ratio (2 color) pyrometer
- ❖ Fiber optics with single color and two color pyrometer
- ❖ Multi wavelength pyrometer specially for Aluminum & other Non - ferrous application
- ❖ Black Body calibration sources
- ❖ Special system for automatic Isothermal Extrusion (MOMAS)
- ❖ Parameter setting Devices



[www accuratesensors.com](http://www accuratesensors.com)

### AST - Accurate Sensors Technologies

Misgav Industrial Park,  
Misgav 20174, Israel  
Ph. : +972-4-9990025, Fax. : +972-4-9990031  
E-mail: [info@accuratesensors.com](mailto:info@accuratesensors.com)

### AST - Accurate Sensing Technologies

188A, B-169 (Part), B-188 & B-189 (A)  
Road No.-5, M.I.A., Madri, Udaipur  
(Rajasthan.) INDIA 313 003  
Ph.: +91-294-3290271  
E-mail: [sales@accuratesensors.com](mailto:sales@accuratesensors.com)